

# Mobile Antenna Catalog

Spring 2014

# 65 Years of Experience

Panorama Antennas, a family business now in its third generation, is a leading designer and manufacturer of antennas for radio communication. Established in London in 1947, Panorama started life as a company manufacturing consumer products. In 1952, buoyed by huge demand for TVs in the UK, Panorama began manufacturing components for televisions, including antennas. With the transistor radio trend of the 1960s, Panorama's expert knowledge of television antennas was put to the manufacture of communication antennas for radio.

Throughout the 70s and 80s Panorama evolved to become the first specialised communication antenna manufacturer in the UK, developing a range of cellular antennas to coincide with the launch of the mobile phone network in Britain. In 1990, Panorama filed a patent application for the first ever solid state coupling circuit, revolutionising cellular glass mount antenna technology and creating a new benchmark for quality in the production of components. As the cellular telecommunications industry has grown worldwide, so has Panorama.

Today Panorama is a producer of antennas for the world's leading communication companies. While Panorama has grown to include 8 international offices, 2 subsidiaries, and over 70 staff; manufacturing, design and development are retained in London less than a mile from the original factory. Our network of international sales representatives means that all customers get the attention and advice they require, providing local support on global scale.

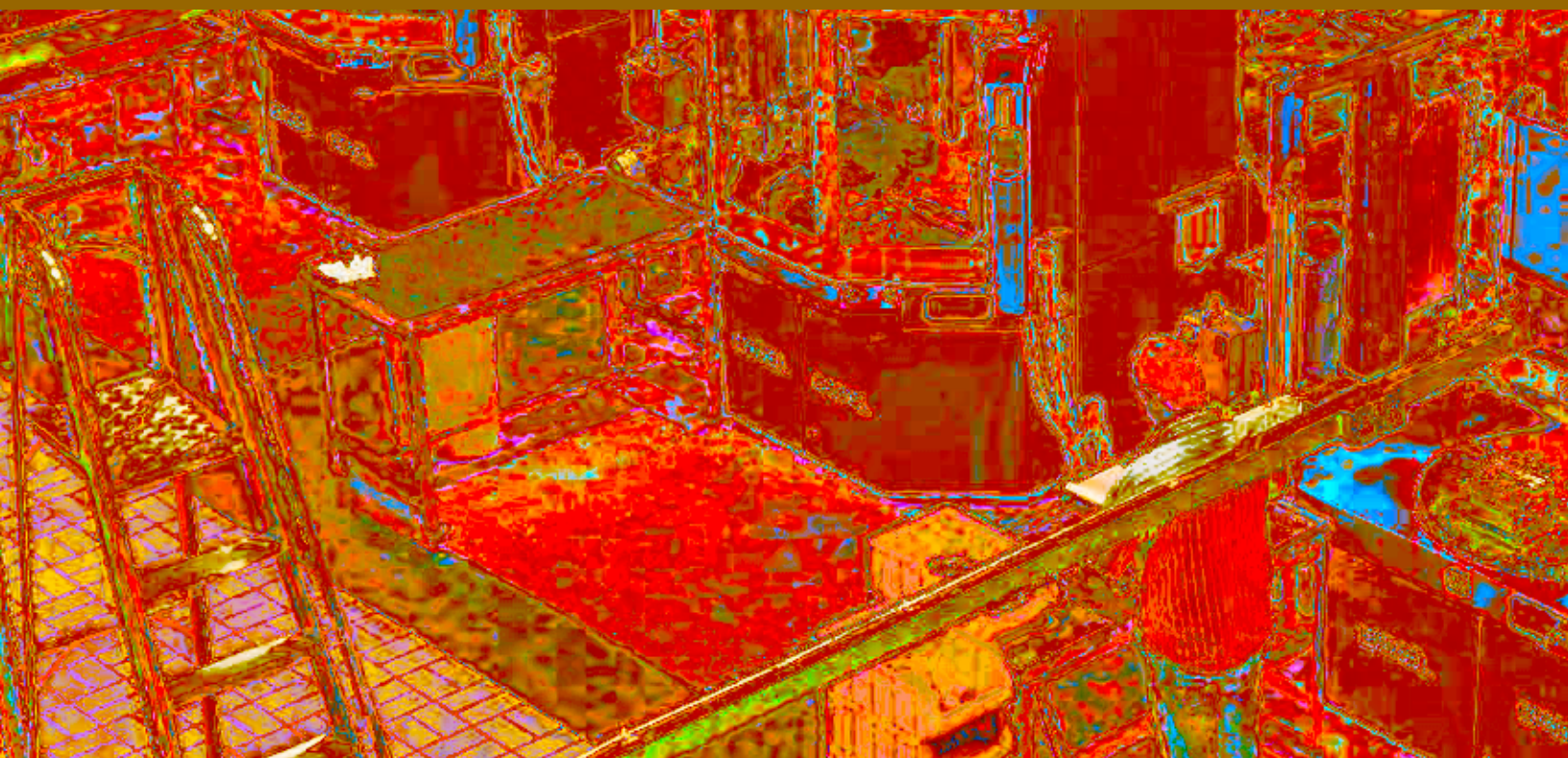

# Contents

4	Quality, Testing & Facilities
6	Modular Antennas
7	Bases
14	Whips
27	Portable Antennas
28	Vehicle Antennas
32	Covert Vehicle Antennas
35	Transit Antennas
36	Fixed Site Antennas
38	GPS Antennas
39	Accessories
44	Adaptors & Connectors
45	Pigtails/Patch Leads
46	Cables & Frequency
48	Customer Forms
51	Contact Us

# Quality As Standard

## Quality Assurance

In 1989, Panorama Antennas became the first antenna manufacturer in Europe to gain ISO 9000 certification. Panorama currently holds the ISO 9001-2008 certificate for quality assurance.



## Patents

Panorama Antennas currently holds several patents and registered designs both in Europe and worldwide.

## RoHS Compliance

All of the products that Panorama Antennas manufactures are 100% RoHS compliant. This is in line with European legislation which came into force on the 1st July 2006. Investment in advanced technology enables Panorama to test all materials supplied to us, as soon as they arrive at the factory, ensuring that noncompliant material is not passed on to the customer.



## REACH

REACH (Registration, Evaluation, Authorisation and Restriction of Chemicals, EC 1907/2007) is the European Union's chemical regulation that came into force on 1 June 2007 and will be phased in over an 11 year period (until 2018). Panorama Antennas wholeheartedly supports the objective of REACH to enhance public health and safety and the protection of the environment. Panorama is committed to meeting REACH requirements and can provide information about substances in accordance with the requirements.

## Associations

Panorama Antennas is currently a member of the following professional associations:

Federation of Communication Services

TETRA Association

British Safety Council

## Contact Us

We are happy to answer your queries. Get in touch and we will help you with any questions you may have.

T: 817-539-1881

E: [us.sales@panorama-antennas.com](mailto:us.sales@panorama-antennas.com)

# Testing & Facilities

Panorama's testing and measurement facilities represent the cutting edge of antenna design capability. Our communication antenna designs are validated before manufacture using accurate and repeatable tests and measurements. This specialist design and development process builds quality and reliability into all Panorama's products. The key components of our measurement system are:

## The Anechoic Chamber

This creates a 1.2m spherical 'quiet zone' in which the performance characteristics of antenna assemblies can be measured at frequencies up to 35GHz, free from physical or electrical conditions that would otherwise interfere with the measurements.

## Network Analysers

Network Analysers measure efficiency using a wide range of parameters including antenna impedance, relative field strength and insertion loss. Results can be displayed in various formats including Smith Chart, VSWR and return loss.

## Turntable & Positioning Controller

The turntable enables the assessment of the directivity of an antenna in both the 'E' and 'H' planes. This special equipment is constructed to rotate through 360 degrees (in 1 degree increments), with minimal RF reflection or interference.

## Antenna Measurement Software

This enables computer control of the Network Analyser and Positioning Controller/Turntable. Data obtained from controlled measurements is automatically displayed on a monitor as VSWR and polar radiation patterns which can be printed or shared on Panorama's computer network.

## Vehicle Ground Plane Simulation

This can be used in the centre of the anechoic chamber to simulate as closely as possible, a typical modern car roof and windscreen (front and rear).

## GPS Satellite Recognition

GPS Antennas rely on continuous communication with the GPS satellites. The GPS Satellite Recognition software enables Panorama to identify each satellite that is being picked up by the GPS antenna. This helps our developers to see how our antennas perform in a real world environment.

## CST Microwave Studio

Panorama uses leading RF modelling software to design, validate & measure antenna forms.

# The Panorama Modular System

Panorama uses a modular base and whip system to enable the highest level of versatility and the best product for your system.

## 1. Pick your base



## 2. Choose your whip

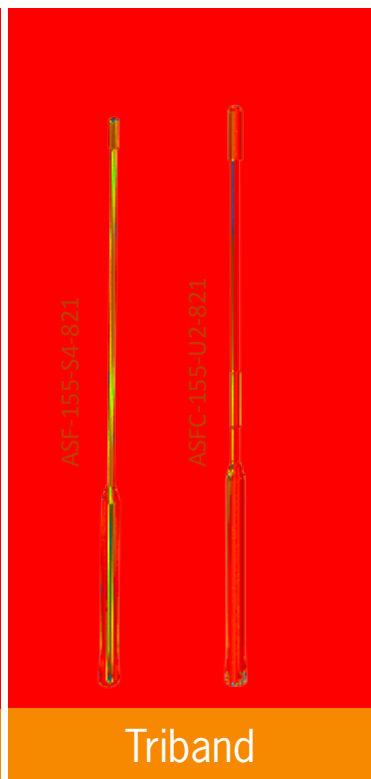
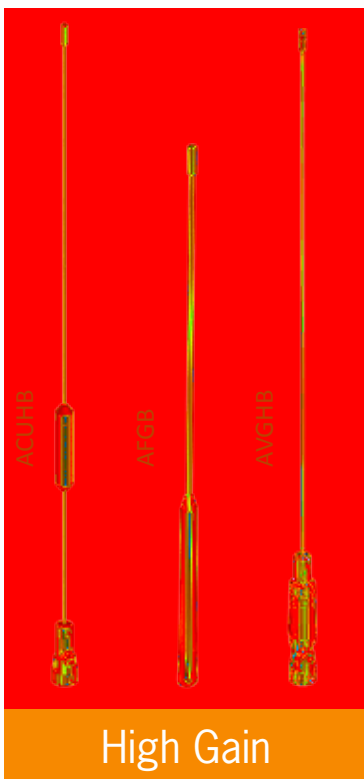
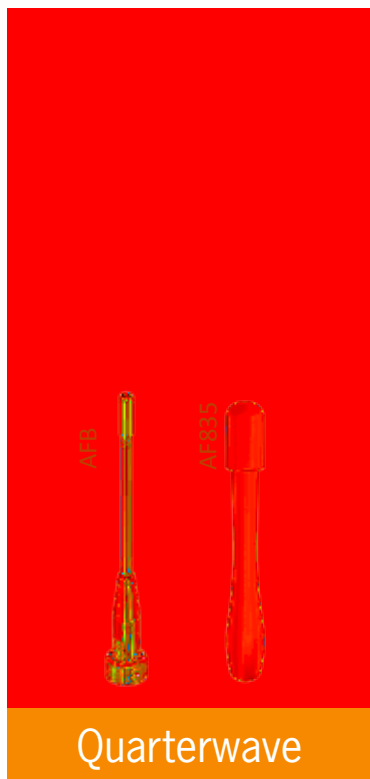

Our whips will sometimes have different part numbers depending on the base - these are specified next to the part number on the product pages.

**M8-5F** List: \$22.14

Part No.		M8-5F	M8-10
<b>Mechanical Data</b>			
Dimensions	Base Height	0.6"	
	Base Diameter	1.1"	
Operating Temp (°F)		-40°/+175°F	
Material		Polyamide, nickel plated brass & stainless steel teeth	
Color		Black	
Hole size	Mounting from inside	0.50"	
	Mounting from outside	0.75"	
Maximum panel thickness		0.16"	
<b>Cable Data</b>			
Type	CS23 (RG58 C/U)	CS23 (RG58 C/U)	
Diameter	0.2"	0.2"	
Length	16'	32'	
Termination	FME (female)	None	

## M8-5F, M8-10

Rugged and durable  
Stainless steel grounding teeth  
Waterproof & corrosion resistant



The M8 is a rugged roof mount base. It incorporates a fully moulded construction with high quality coaxial cable for low loss and long term reliability with stainless steel grounding teeth, good grounding is guaranteed for better performance.

The base is easy to fit and can also be installed from outside the vehicle if under panel access is not available.

With the modular stud fitting, many different whips in the Panorama range can be fitted to the base.

*Other cable lengths and terminations available*

## M8A-5F, M8A-10

Rugged and durable  
Stainless steel grounding teeth  
Waterproof & corrosion resistant  
For thick panels



The M8A is a rugged roof mount base with an extra long reach for thicker panels.

It incorporates a fully moulded construction with stainless steel earthing brackets and high quality coaxial cable for low loss and long term reliability.

The base is easy to fit and can also be installed from outside the vehicle if under panel access is not available.

With the modular stud fitting, many different whips in the Panorama range can be fitted to the base, and the central locking screw ensures a secure, watertight base even without a whip installed.

*Other cable and lengths and terminations available*

**M8A-5F** List: \$ 22.14

**M8A-10** List: \$26.88

Part No.		M8A-5F	M8A-10
<b>Mechanical Data</b>			
Dimensions	Base Height	0.6"	
	Base Diameter	1.1"	
Operating Temp (°F)		-40°/+175°F	
Material		Polyamide, nickel plated brass & stainless steel teeth	
Color		Black	
Hole size	Mounting from inside	0.50"	
	Mounting from outside	0.75"	
Maximum panel thickness		0.24"	
<b>Cable Data</b>			
Type	CS23 (RG58 C/U)	CS23 (RG58 C/U)	
Diameter	0.2"	0.2"	
Length	16'	32'	
Termination	FME socket (female)	None	

**MMR-5F** List : \$42.40

**MD-5F** List : \$36.62

Part No.			
		MMR-5F	MD-5F
<b>Mechanical Data</b>			
Dimensions	Base Height	1.6"	1.5"
	Base Diameter	4"	3"
Operating Temp (°F)		-40°/+175°F	
Material		Polyamide & nickel plated brass	
Color		Black	
<b>Cable Data</b>			
Type	CS23 (RG58 C/U)	CS23 (RG58 C/U)	
Diameter	0.2"	0.2"	
Length	16'	16'	
Termination	FME Socket (female)	FME Socket (female)	

## MMR & MD

Strong magnetic retention  
Interchangeable whips

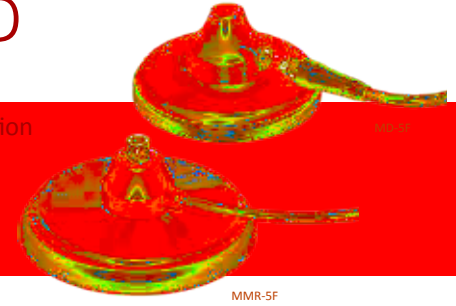

The MMR and MD both provide a strong magnetic retention and all the benefits of a solution that can be installed without drilling and removed without a trace.

A magnetic base ensures that the whip stays securely fastened to the vehicle with no need for permanent installations and can handle long whips designed for low frequencies.

The MMR magnetic mounts incorporate a fully moulded construction with high quality coaxial cable for low loss and long term reliability. This heavy duty option ensures an extremely secure installation with a fitting for modular Panorama whips.

The MD mid range magnet mount supports all Panorama radiators and detachable low loss cable for ultimate versatility and easy storage.

*Other cable lengths and terminations available*

## MBM-5F

Trunk lid mount  
Removed without a trace  
Modular stud fitting  
Interchangeable whips

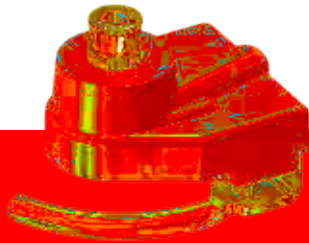

The MBM-5F is a trunk clip base designed for fixing around the vehicles panels. It incorporates a fully moulded construction with high quality coaxial cable for low loss and long term reliability.

The base can be used with a wide range of modular whips for a secure mounting that can be removed without vehicle damage.

**MBM-5F** List: \$35.20

Part No.		
MBM-5F		
<b>Mechanical Data</b>		
Dimensions	Base Height	0.9"
	Base Length	1.7"
	Base Width	1.5"
Operating Temp (°F)		-40°/+175°F
Material		Polyamide & nickel plated brass
Color		Black
<b>Cable Data</b>		
Type	RG58	
Diameter	0.2"	
Length	16'	
Termination	FME Socket (female)	



# NMO Base & Adaptor

MNMOM-5F List: \$19.07

SAB-181 List: \$3.65

## Roof mount

Suitable for various whips and applications

SAB-181 allows standard Panorama whips to be used on NMO bases

The Panorama 'NMO' 3/4 inch panel mount antenna base combines compatibility with NMO style antennas. Constructed from nickel plated brass to prevent corrosion. The earthing teeth are stainless steel to provide excellent earth contact with every installation.

The Panorama SAB-181 NMO adaptor offers compatibility between Panorama modular antennas and standard NMO panel mount bases. Designed in sturdy Nylon, with a secure TPU boot or 'o' ring for sealing to the mounting surface.

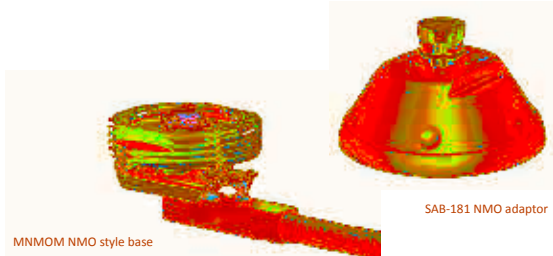

Part No.		MNMOM-5F
<b>Mechanical Data</b>		
Dimensions	Height	0.75"
	Diameter	1-1/8"
Operating Temp (°F)		-40°/+175°F
Material		Nylon, nickel plated brass & stainless steel
Hole Size		3/4"
Maximum panel thickness		0.08"
Minimum panel thickness		0.03"
<b>Cable Data</b>		
Type		C23 (RG58 C/U)
Diameter		0.2"
Length		17'
Termination		FME Socket (female)

## Technical Drawing

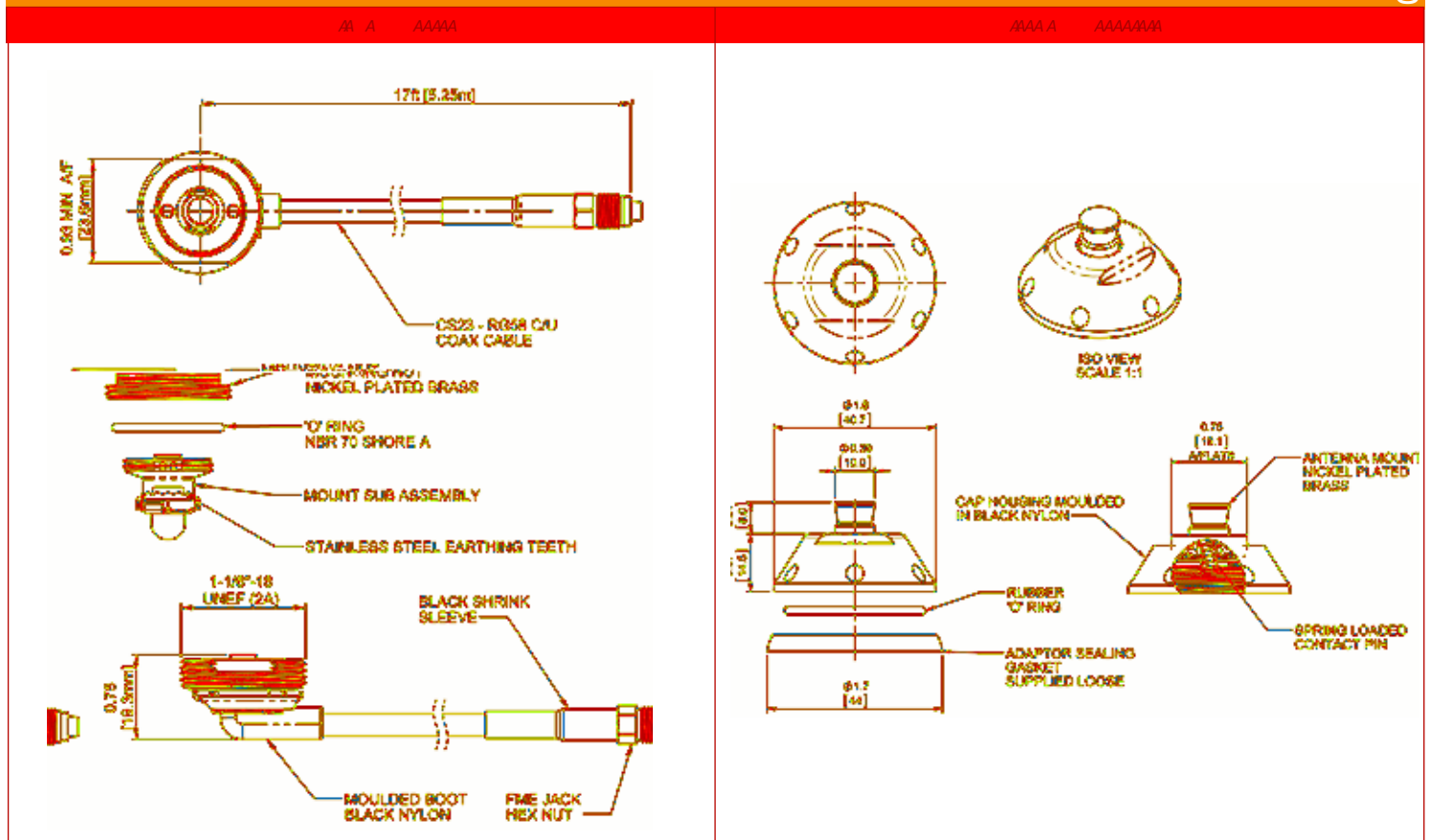

GPSB List: \$142.64

## The Sharkee® (GPSB)



### Technical Drawing

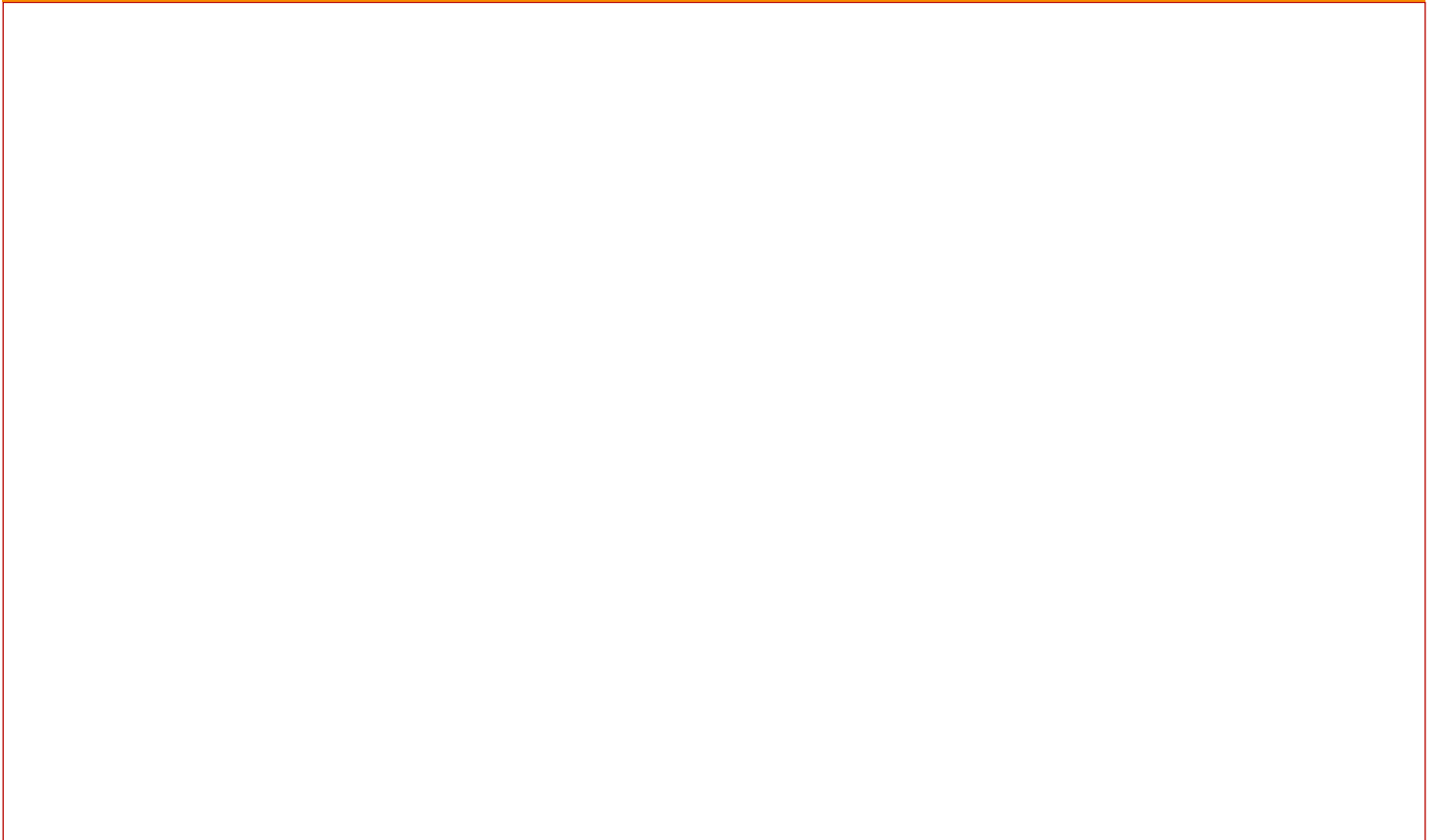

Electrical Data	
Frequency Range (MHz)	698- 894, 1710-2170, 2200-2700 & 4900-5800
Operational Band	LTE 700, AMPS850, GSM1800, PCS1900, 3G UMTS/AWS, 2.4 & 5.8GHz WiFi, WLAN, WiMAX/ Public Safety 4.9GHz
Gain: Isotropic	2dBi (on all bands)
Compared to ¼ wave	0dBd (on all bands)
Polarization	Vertical
Pattern	Omnidirectional
Impedance	50Ω
Max Input Power (W)	Internal elements 25w /Main whip 60w
GPS Data	
Frequency Range (MHz)	1575
VSWR	<1.5:1 ± 4MHz
Gain: LNA	26dBd
Polarization	Right Hand Circular
Operating Voltage	3-7V DC ed C la

GPSK-FF List: \$94.08

Part No.		GPSK-FF
<b>Electrical Data</b>		
Frequency Range (MHz)	Dependent on whip	
Gain	Dependent on whip	
Impedance	50Ω	
Max Input Power (W)	60	
<b>GPS Data</b>		
Frequency Range (MHz)	1575	
Peak Gain	26dBd	
<b>Mechanical Data</b>		
Operating Temp (°F)	-40°/+175°F	
<b>Cable Data</b>		
Type	RG174	
Termination	GPS	FME Socket (female)
	Comms	FME Plug (male)

## GPSK-FF

- Active GPS element
- Secure roof mounting
- Easy installation

The GPSK antenna range is a dual function, high performance mobile antenna with an active GPS element.

The GPSK range covers frequencies from 139MHz to 2.4GHz, with a detachable whip depending on the equipment requirements. With the ability to mount on a roof up to 0.2" thick using only a single 0.6" hole. The dual functionality of the Panorama GPSK range makes the antenna a popular choice for public safety and utility applications.

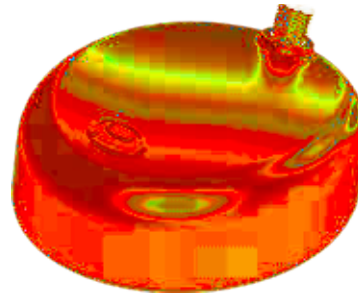

## Technical Drawing

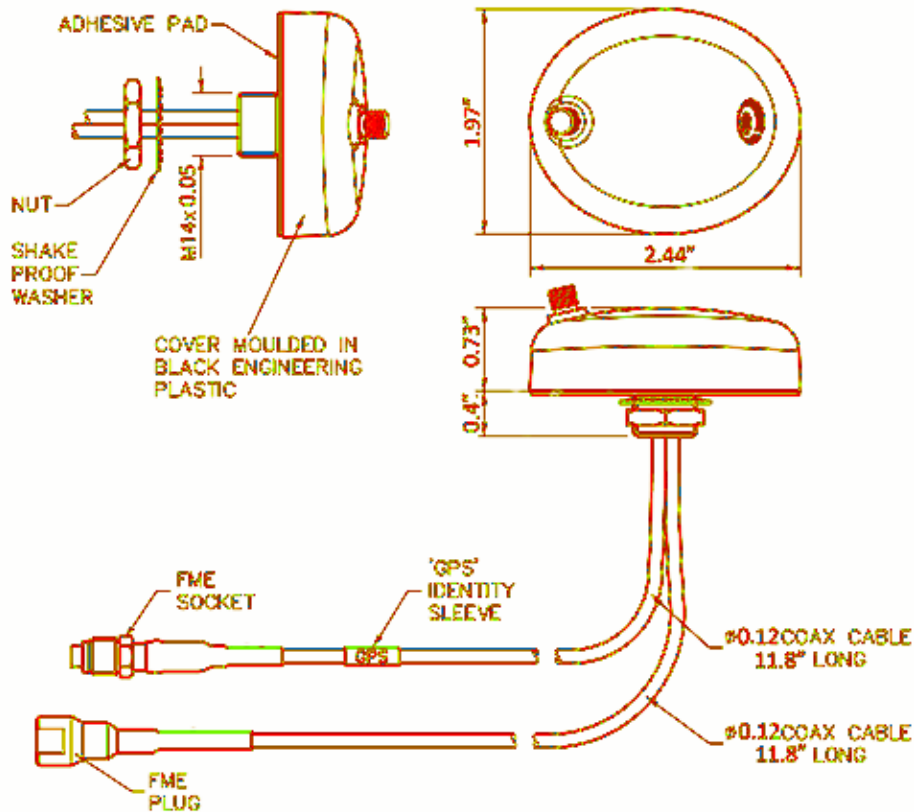

## GPSB4

GPSB4 List: \$142.64

Four elements in one sleek housing  
GPS and dual WLAN/WIMAX in one antenna  
Wireless a, b, g, n MIMO

The GPSB4 series antenna provides for multiple RF technologies within one antenna housing. Requiring only a single hole fixing, the GPSB4 reduces vehicle damage, cost of installation and visual impact.

The OEM shark fin style design provides multiple antenna functions while remaining discreet.

The GPSB4 is suitable for public safety (covert and discreet) and transportation applications, where a cost effective and efficient antenna is essential to the system.



Part No.		GPSB4
<b>Electrical Data</b>		
Frequency Range (MHz)	2200-2700 & 4900-6000	
Gain Internal elements)	0dBd (unity)	
Bandwidth @ 2:1 VSWR	Dependent on whip	
Impedance	50Ω	
Max Input Power (W)	Internal elements 25/main whip 60	
<b>GPS Data</b>		
Frequency Range (MHz)	1575	
Peak Gain	26dB	
<b>Mechanical Data</b>		
Operating Temp (°F)	-40°/+175°F	
Ingress Protection	IP66 when correctly installed	
<b>Cable Data</b>		
Type	RG174	
Termination	Whip	FME Plug (male)
	GPS	FME Socket (female)
	WLAN1	SMA Socket (female)
	WLAN2	SMA Socket (female)

## Technical Drawing

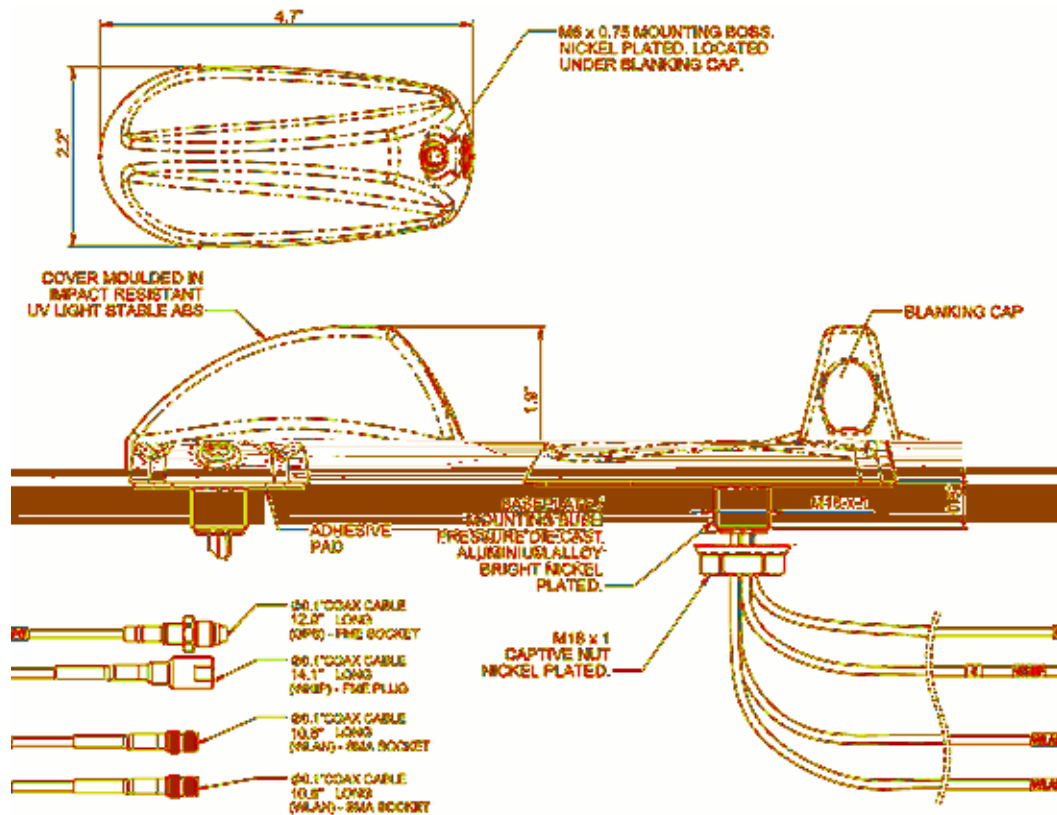

# Selecting a Whip

## Gain

### 0dBd Gain

Flexible or rigid options  
Standard Element  
Rugged and durable build

Standard 0dBd whips are a multipurpose antenna used in most urban environments when good reception is required and the signal may not be coming from the horizon.

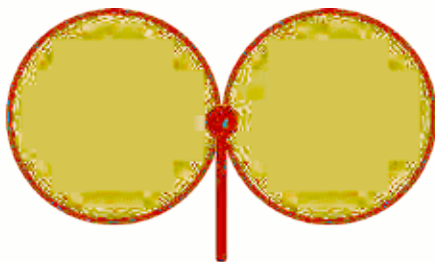

### 3-5dBd Gain

High gain  
Flexible or tapered options  
Rugged and durable build

3-5dBd whips are more suited to suburban and rural environments where the signal is more likely to be coming from the horizon.



## Frequency

Many of our whips are cut to frequency

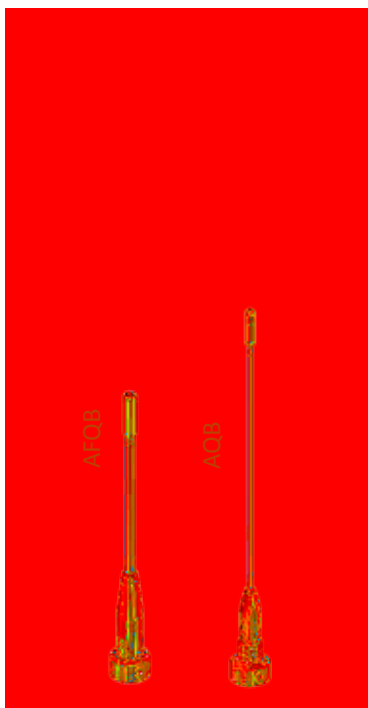

Quarterwave

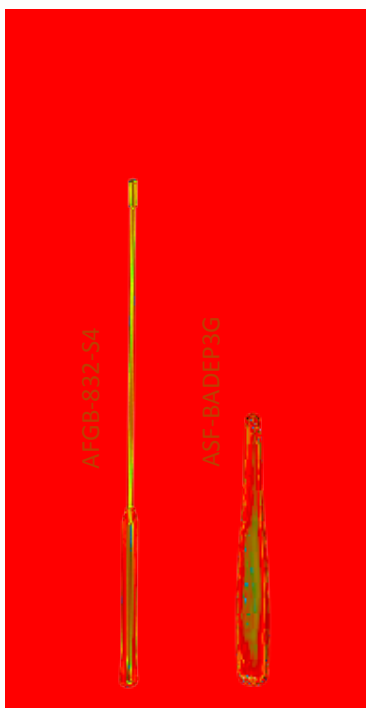

Dualband

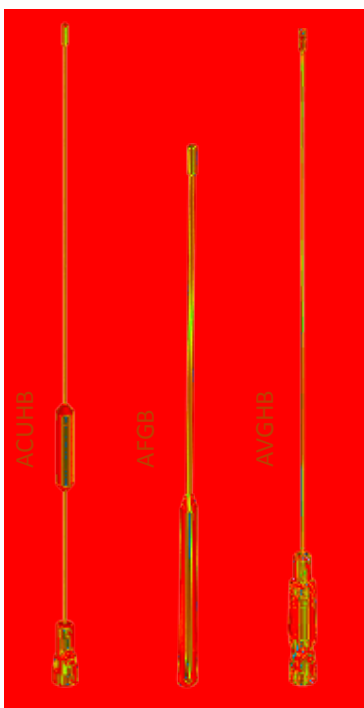

High Gain

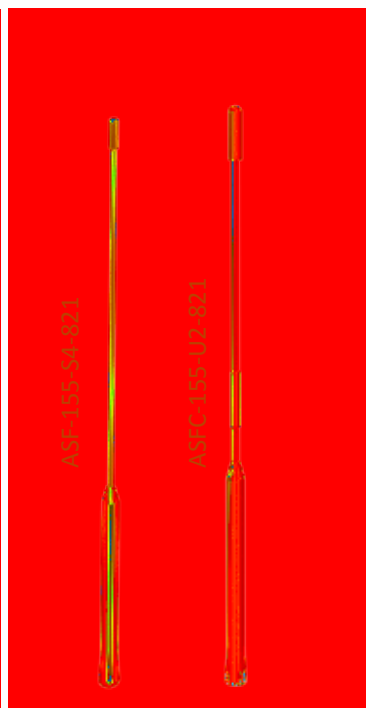

Triband

## AQB Range, AQHB Range, AS Range

Rigid whip  
Removable for car wash  
Hinged & non-hinged versions

This range of rigid antennas feature a 17-7 PH stainless steel rod and plated brass terminal. The antennas are black chrome plated to improve durability without impacting RF performance.

The Panorama modular mounting system provides a high degree of interchangeability between whips and bases, making them suitable for all applications whether temporary or permanent.



AQB Range List: \$13.62  
AQHB Range List: \$17.22  
AS range List: \$8.06

Part No.				
Non-hinged adaptor version [M8]	AQB-H5	AQB-H6A	AQB-S4	AQB-U2
Hinged adaptor version [M8]	AQHB-H5	AQHB-H6A	AQHB-S4	AQHB-U2
Non-hinged version [GPSB/GPSK]	AS-H5	AS-H6A	AS-S4	AS-U2
Electrical Data				
Frequency Range (MHz)	149-159	155-174	450-470	450-512
Peak Gain	0dBd (unity)			
Bandwidth @ 2:1 VSWR	12%			
Impedance	50Ω			
Max Input Power (W)	100			
Mechanical Data				
Operating Temp (°F)	-40°/+175°F			

Whips are tuned to frequency: to see the full band plan and alternative frequency ranges these whips can cover, see page 48.

## Technical Drawing

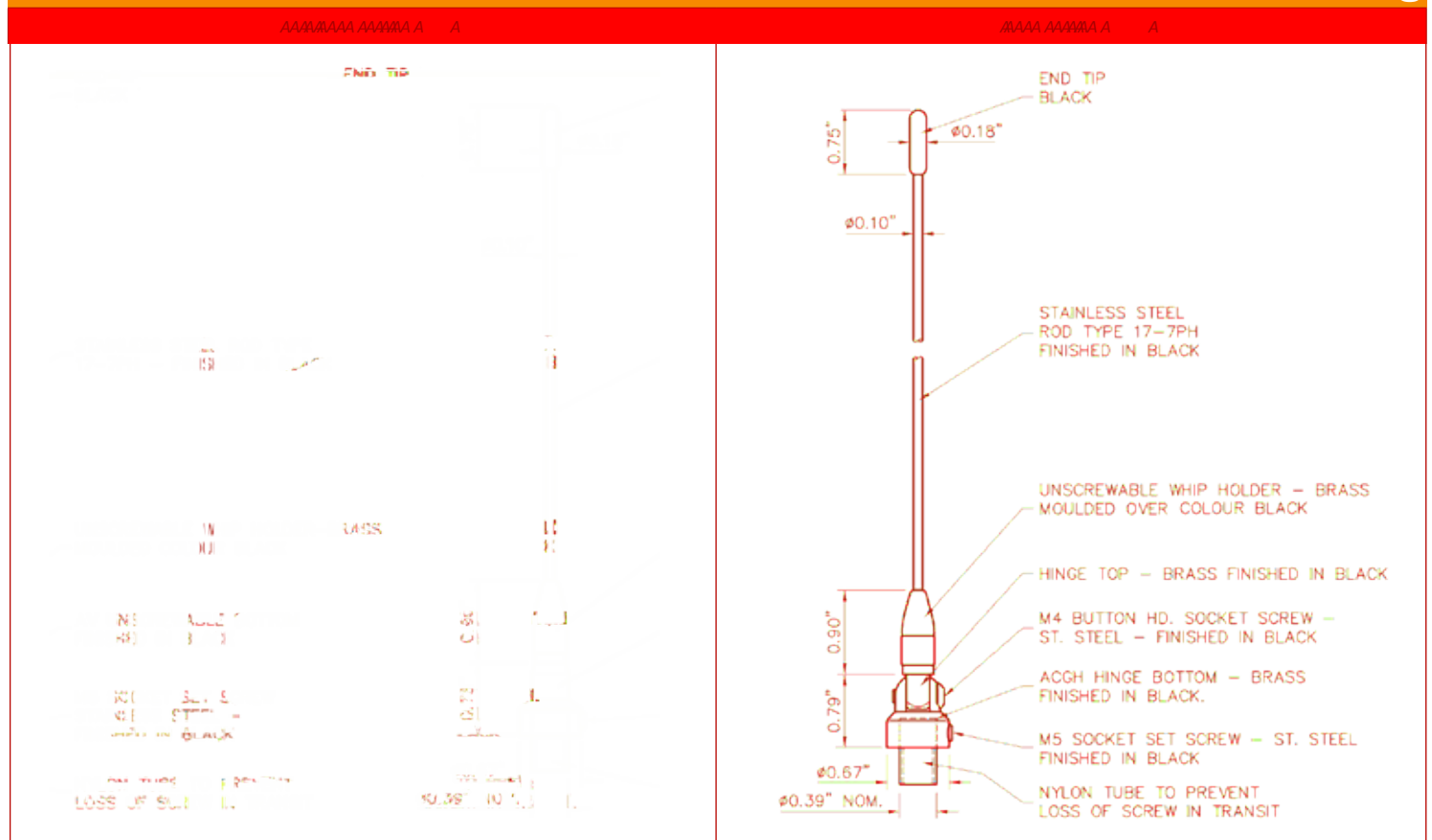

AFB Range List: \$10.75  
 AFQB Range List: \$15.97  
 AFQHB Range List: \$20.67

Part No.				
Non-hinged adaptor version [M8]	AFQB-H5	AFQB-H6A	AFQB-S4	AFQB-U2
Hinged adaptor version [M8]	AFQHB-H5	AFBQ	AFQHB-S4	AFQHB-U2
Non-hinged version [GPSB/GPSK]	AFB-H5	AFB-H6A	AFB-S4	AFB-U2
Electrical Data				
Frequency Range (MHz)	149-159	155-174	450-470	450-512
Gain	0dBd (unity)			
Bandwidth @ 2:1 VSWR	12%			
Impedance	50Ω			
Max Input Power (W)	100			
Mechanical Data				
Operating Temp (°F)	-40°/+175°F			

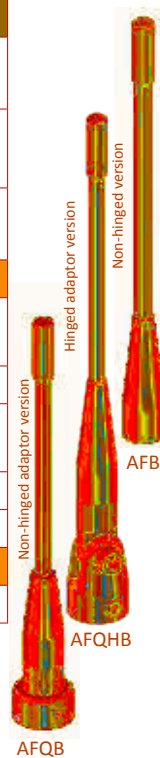

## AFB Range, AFQB Range, AFQHB Range

Flexible whip  
 Removable for car wash  
 Hinged & non-hinged versions

The AFQB range of flexible 1/4 antennas for UHF feature a flexible construction within a black nylon tube. This provides damage resistance without compromising RF performance.

The AFBQ range of flexible antennas for VHF feature an overmoulded shock spring and stainless steel rod.

The Panorama modular mounting system provides a high degree of interchangeability between whips and bases, making them suitable for all applications whether temporary or permanent.

Whips are tuned to frequency: to see the full band plan and alternative frequency ranges these whips can cover, see page 48.

## Technical Drawing

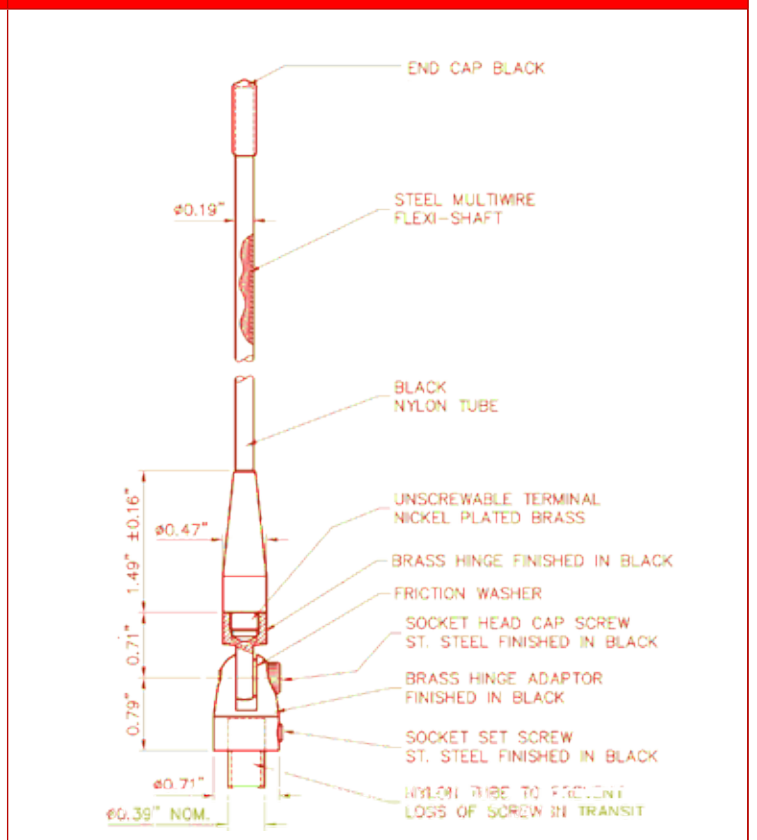
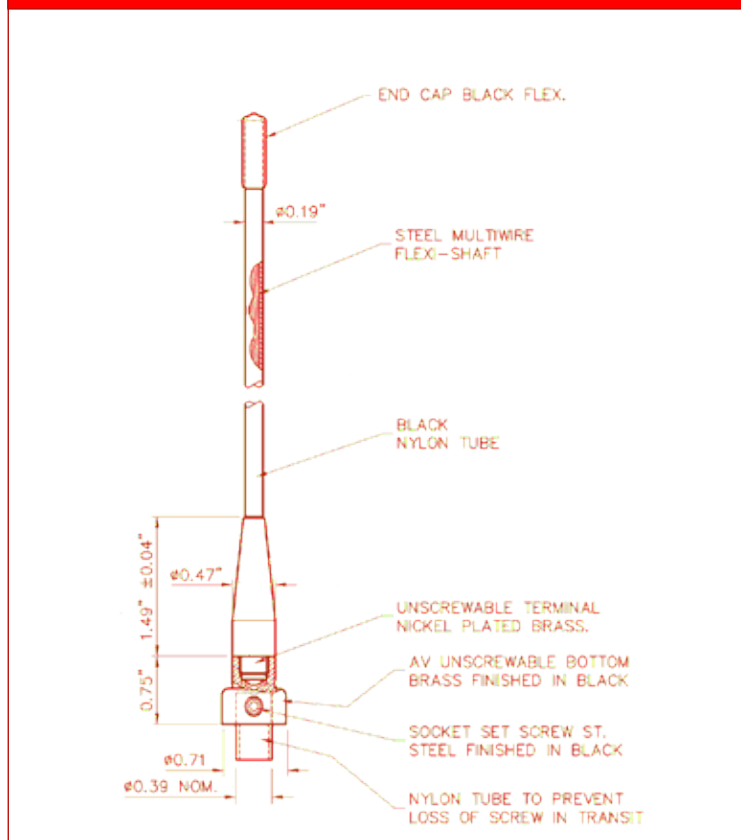



## AFNT Range, AFQNT Range

Ultra flexible whip  
Nickel titanium rod  
Ideal for low clearance situations

This antenna features a super flexible nickel titanium memory wire rod. This flexibility provides a high degree of damage resistance making the antenna virtually indestructible.

The antenna comes in 2 versions, offering the same electrical performance for both the combi antenna (GPSB/GPSK) mounting system and the M8 mounting system.

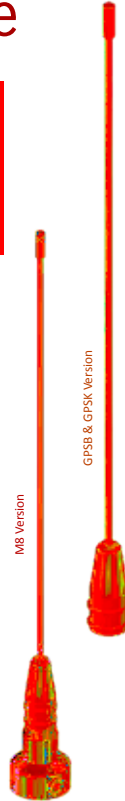

AFNT Range List: \$20.80  
AFQNT Range List: \$26.03

Part No.				
Non-hinged version (GPSB/GPSK)	AFNT-H5	AFNT-H6A	AFNT-S4	AFNT-U2
Non-hinged adaptor version (M8)	AFQNT-H5	AFQNT-H6A	AFQNT-S4	AFQNT-U2
Electrical Data				
Frequency Range (MHz)	149-159	155-174	450-470	450-512
Peak Gain	0dBd (unity)			
Bandwidth @ 2:1 VSWR	12%			
Impedance	50Ω			
Max Input Power (W)	100			
Mechanical Data				
Operating Temp (°F)	-40°/+175°F			

Whips are tuned to frequency: to see the full band plan and alternative frequency ranges these whips can cover, see page 48.

## Technical Drawing

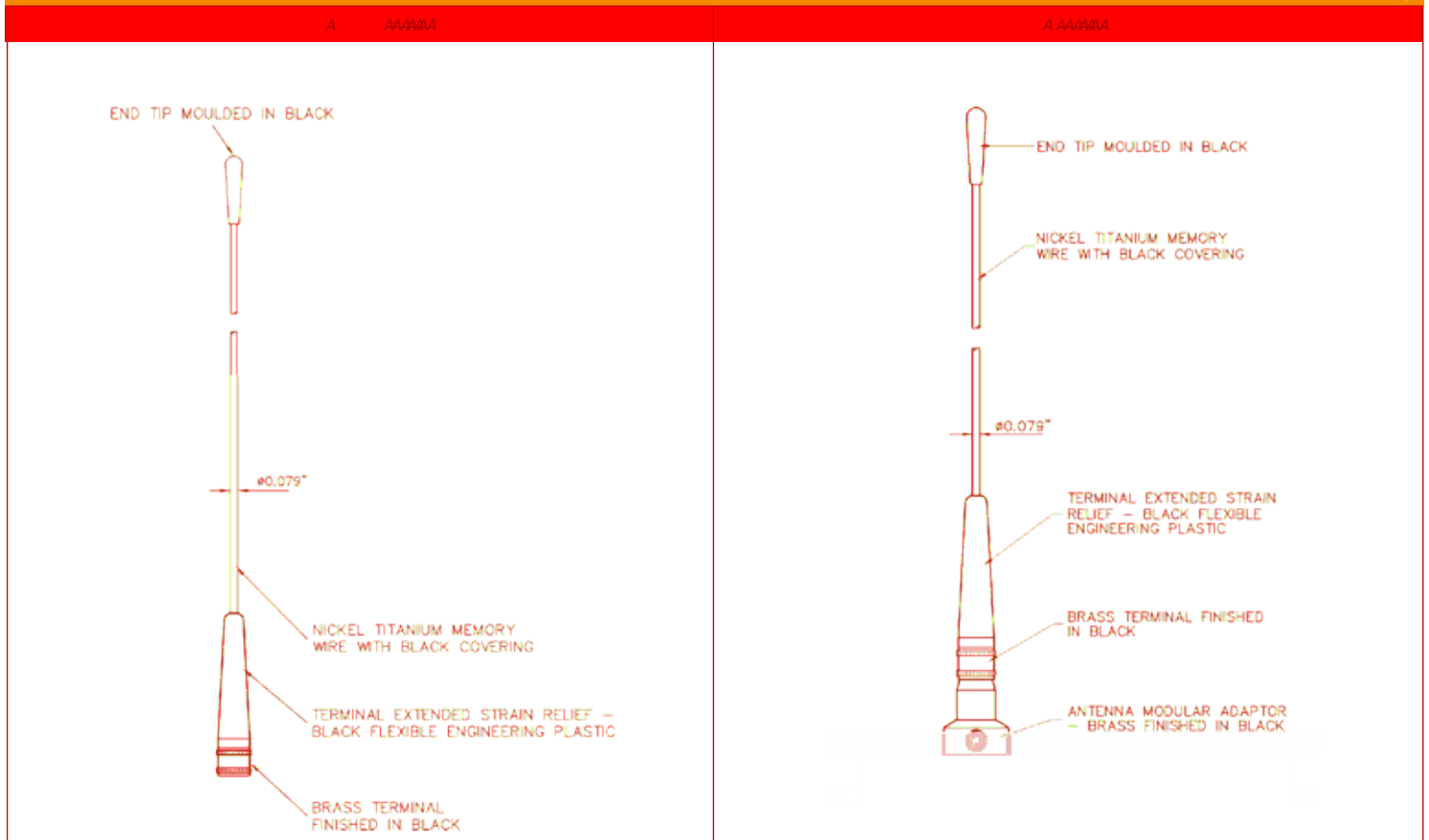

AF835 List: \$10.75

Part No.	
(GPSB/GPSK)	AF835
Electrical Data	
Frequency Range (MHz)	806-870
Peak Gain	0dBd
Bandwidth @ 2:1 VSWR	10%
Impedance	50Ω
Max Input Power (W)	60
Mechanical Data	
Operating Temp. (°F)	-40°/+175°F

## AF835

Flexible compact whip  
Removable for car wash  
Compact LTE option

The AF835 provides a rugged and compact option covering 806-870MHz for cellular LTE.

With a M6 x 0.75 base this fits combi base mounts such as the GPSK & GPSB.



## Technical Drawing

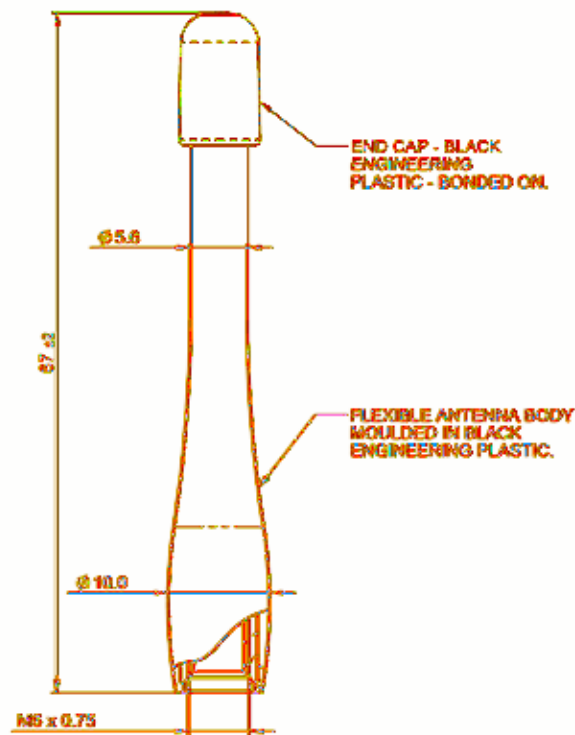

## AVGHB Range

High gain  
 Hinged mount for non-horizontal surfaces  
 Perfect for fringe coverage areas

The "AVGB" range is a durable roof mounted solution for vehicle installations requiring gain at VHF frequencies. The antenna offers a 3dBd gain thanks to a fully encapsulated base matching coil.

The radiator is fabricated from high quality 17-7PH stainless steel and can be removed for low clearances or car washes. The antenna is compatible with the M8 range of Panorama Antennas modular bases and features a convenient hinge mounting.



AVGHB Range List: \$38.40

Part No.	
Hinged adaptor version (M8)	AVGTHB
Electrical Data	
Frequency Range (MHz)	136-174 (banded)
Peak Gain	3dBd
Bandwidth @ 2:1 VSWR	8%
Impedance	50Ω
Max Input Power (W)	100
Mechanical Data	
Operating Temp (°F)	-40°/+175°F

*Tuned to frequency - for more information on frequency bands see page 48.*

## Technical Drawing

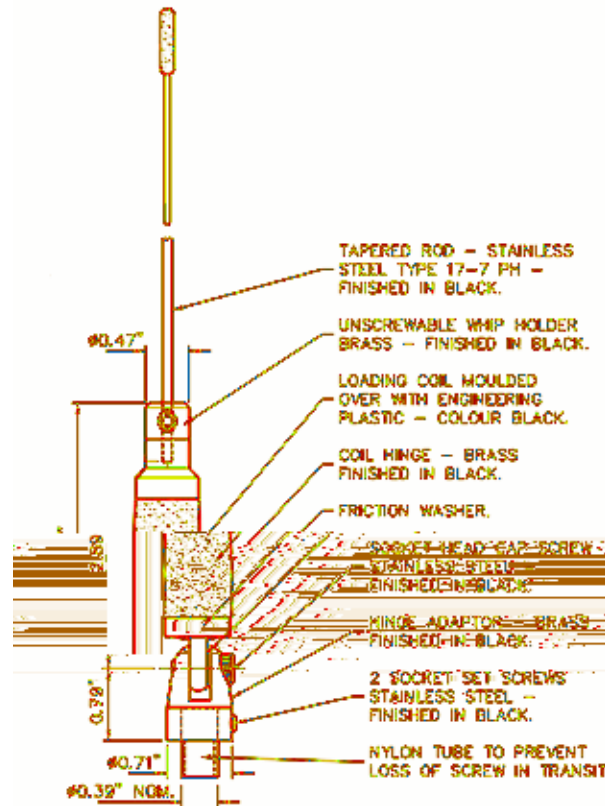

**AFGB-832** List: \$27.89

**AFGB-S4** List: \$27.89

Part No.	AFGB-S4	AFGB-832
<b>Electrical Data</b>		
Frequency Range (MHz)	450-470	760-876
Peak Gain	3dBd	3dBd
Bandwidth @ 2:1 VSWR	15%	15%
Impedance	50Ω	50Ω
Max Input Power (W)	60	60
<b>Mechanical Data</b>		
Operating Temp (°F)	-40°/+175°F	-40°/+175°F

## AFGB-832, AFGB-S4

- Flexible high gain whip
- Removable for car wash
- Sportflex body for high durability

The AFGB range of whips feature a 17-7ph stainless steel rod covered with a black sleeve & a sportflex style body for added resilience & durability. With an M6 x 0.75 thread this antenna range fits on the combi antenna bases (GPSB/ GPSK).



## Technical Drawing

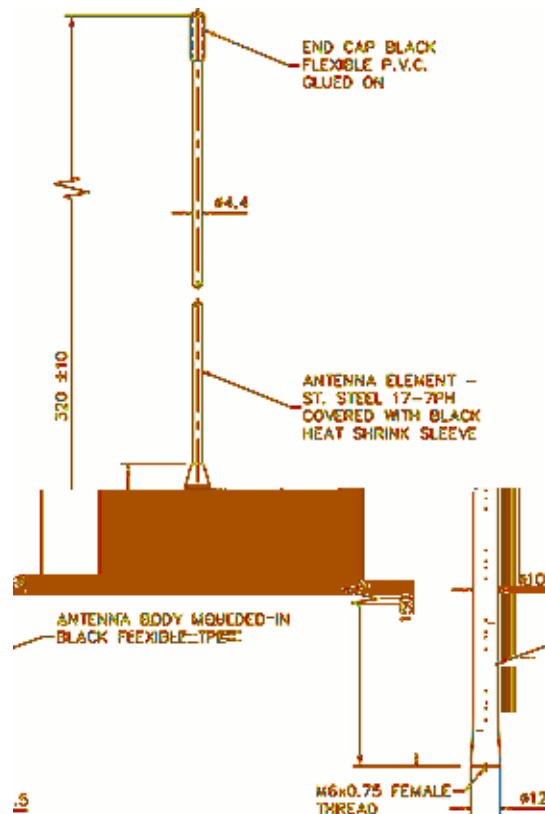

## ACUHB

5dBd peak gain  
Hinged adaptor for mounting on non horizontal ground plane

The ACUHB offers high gain and rugged design to create an efficient and durable product. The hinge adaptor ensures that the antenna can always be correctly polarised even when installed on a non horizontal ground plane, and protects the antenna from damage in low clearance situations.

The 5dBd gain will provide a significant boost to performance in remote or fringe locations. Or used to the narrow bandwidth, lower gain antennas will be more suitable in urban or suburban locations.

With a hinged whip for mounting on horizontal ground planes using the M8 base.

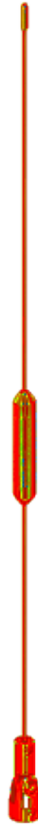

ACUHB List: \$29.73

Part No.	
Hinged version [M8]	ACUHB
Electrical Data	
Frequency Range (MHz)	380-470 (tuned to frequency)
Peak Gain	5dBd
Impedance	50Ω
Max Input Power (W)	50
Mechanical Data	
Operating Temp (°F)	-40°/+175°F

*Whips tuned to frequency: to see the full band plan see page 48.*

## Technical Drawing

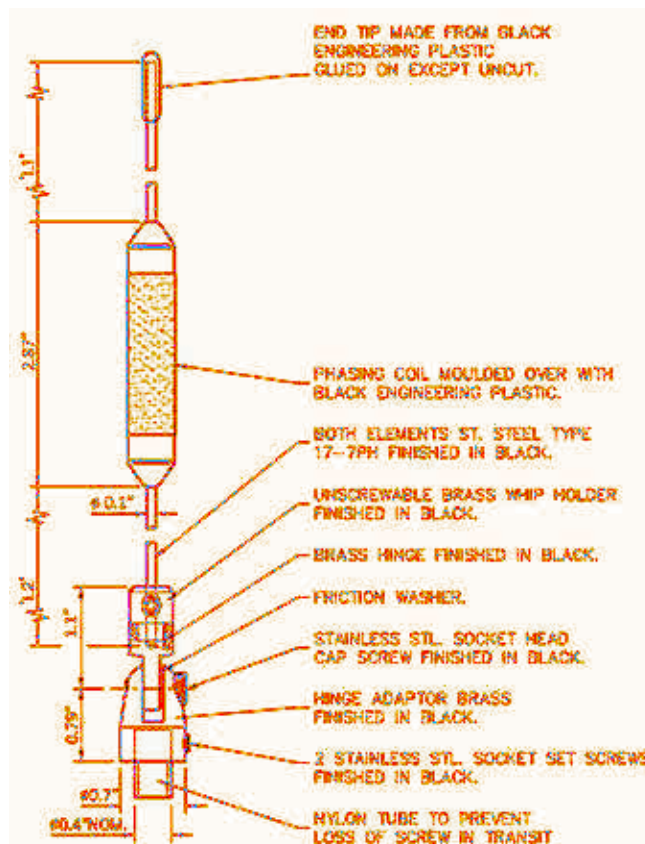

**AFGB-832-S4** List: \$43.36

**AFGQB-832-S4** List: \$52.16

Part No.		
Non-hinged version (GPSB & GPSK)		AFGB-832-S4
Antenna for M8		AFGQB-832-S4
Electrical Data		
Frequency Range (MHz)		450-470/764-876
Peak Gain	145-174MHz	-
	450-470MHz	0dBd (unity)
	764-900MHz	3dBd
Impedance		50Ω
Max Input Power (W)		60
Mechanical Data		
Operating Temp (°F)		-40°/+175°F

## AFGB-832-S4, AFGQB-832-S4

Multiband performance

UHF 7/800MHz

Flexible overmoulded construction

Designed specifically for a new generation of dual band radios, UHF 450-470MHz, 700 & 800MHz bands. The antenna whip is stylish, discreet and durable, featuring an overmoulded coil base section and tapered stainless steel rod.

The antenna is flexible for added damage resistance and can be mounted on a range of Panorama modular, magnetic or GPS combination bases and can help to reduce the number of visible antennas on a vehicle.



## Technical Drawing

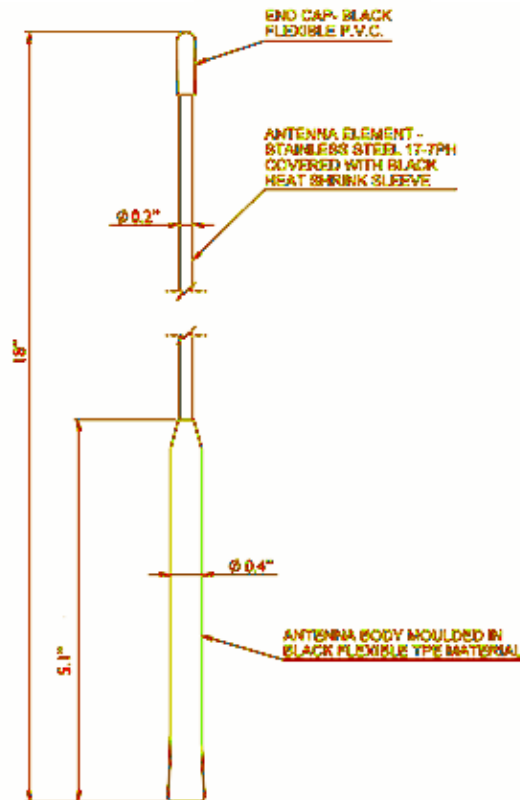

# ASF-BADEP3G



Part No.	
[GPSB/K]	ASF-BADEP3G
Electrical Data	
Frequency Range (M	

A

## Technical Drawing



ASF-155-S4-821 List: \$47.89

ASFQHB-155-S4-821 List: \$56.69

Part No.		
Non-hinged version [GPSB & GPSK]	ASF-155-S4-821	
Antenna for M8	ASFQHB-155-S4-821	
Electrical Data		
Frequency Range (MHz)	145-174, 420-480 & 764-894	
Peak Gain	160MHz	0dBd
	450MHz	-3dBd
	800MHz	0dBd
Impedance	50Ω	
Max Input Power (W)	100	
Mechanical Data		
Operating Temp (°F)	-40°/+175°F	

## ASF-155-S4-821 & ASFQHB-155-S4-821

Multiband performance  
UHF, VHF & 7/800MHz  
Flexible overmoulded construction

Designed for a new generation of tri-band radios the ASF/ASFQHB-155-S4-821 covers VHF 145-174MHz, UHF 420-480MHz and the 700 and 800MHz bands. The antenna whip is stylish, discreet and durable featuring an overmoulded coil base section and tapered stainless steel rod.

The antenna is flexible for added damage resistance and can be mounted on GPS combination bases and can help to dramatically reduce the number of visible antennas on a vehicle.



## Technical Drawing

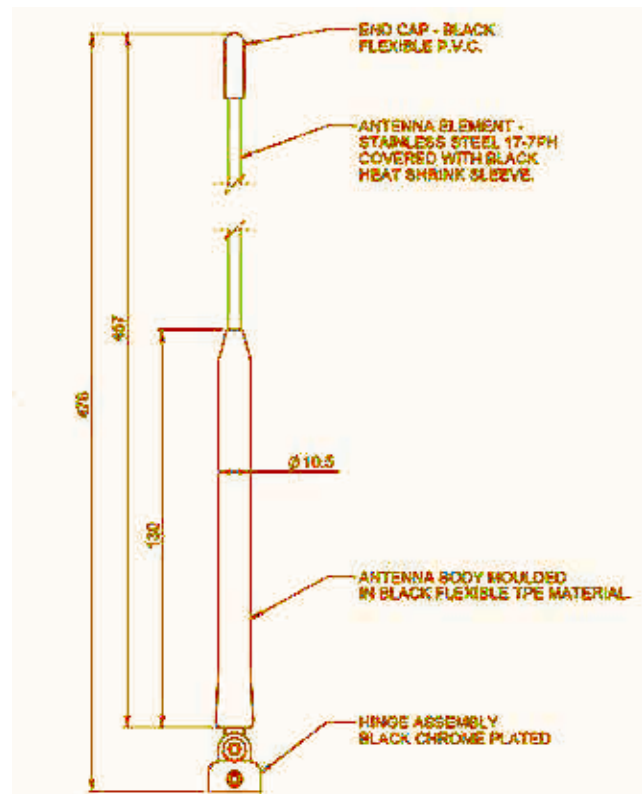
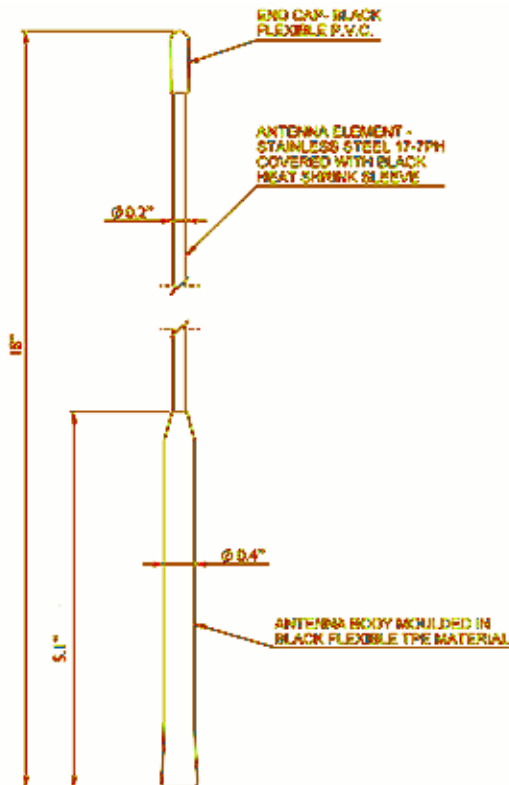



## ASFC-155-U2-821

ASFC-155-U2-821 List: \$64.00

### Tri-band Performance

Flexible rod with wound element

Fits Panorama modular & combination bases

The ASFC-155-U2-821 covers VHF 150-160MHz, UHF 450-520MHz and the 700 and 800MHz bands. The antenna whip is stylish, discreet and durable featuring a flexible overmoulded base section and a black jacketed flexible wound rod element.

The ASFC-155-U2-821 antenna can be mounted on a range of Panorama magnetic or GPS combination bases.



Part No.		
Non-hinged [GPSB/GPSK]	ASFC-155-U2-821	
Electrical Data		
Frequency Range (MHz)	150-160/450-520 /764-876	
Peak Gain	155MHz	0dBd
	480MHz	0dBd (unity)
	700MHz	0dBd (unity)
Impedance	50Ω	
Max Input Power	60	
Mechanical Data		
Operating Temp (°C)	-40°/+80°C (-40°/+176°F)	

## Technical Drawing

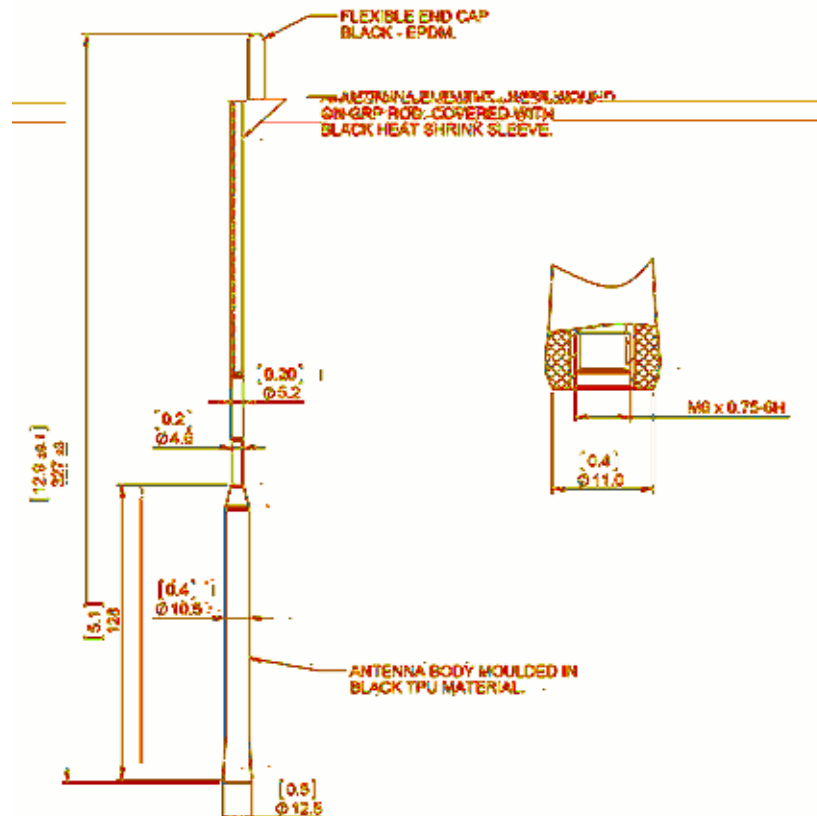

AVWB-SM-39-68 List: \$40.58

Part No.	
Non-hinged adaptor version (M8)	AVWB-SM-39-68
Electrical Data	
Frequency Range (MHz)	138-169
Peak Gain	0dBd (unity)
VSWR	≤ 2.2:1
Impedance	50Ω
Max Input Power (W)	100
Mechanical Data	
Operating Temp (°F)	-40°/+175°F

## AVWB-SM-39-68

Wide band VHF antenna  
Shock mount base

The AVWB is designed for vehicles that need a wide VHF range and require a rugged antenna.

The AVWB is compatible with all of the modular bases in the Panorama range.

Supplied with an integrated shock mount, the antenna is protected from impact and damage in low clearance situations.



## Technical Drawing

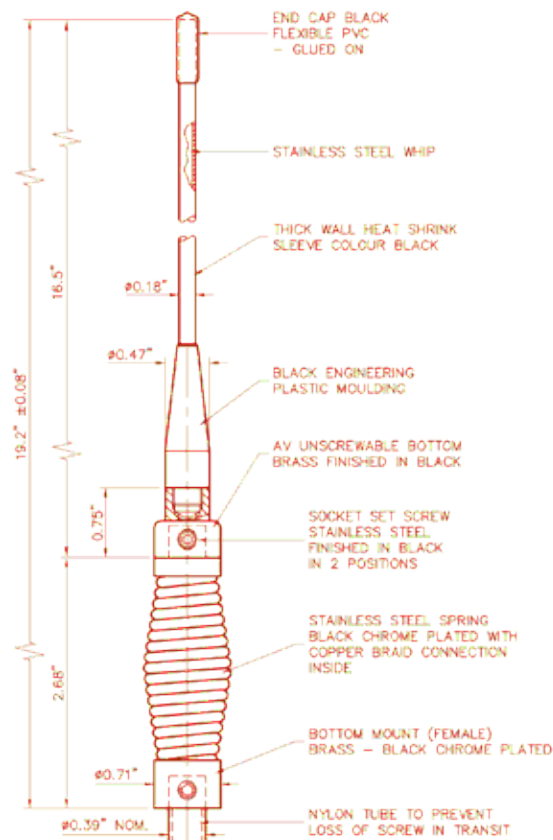

## Life Long Partner

Panorama offers a comprehensive range of portable antennas. The MFX, MXK, PXX and MQ range are totally overmoulded in TPE or TPU thermoplastic while the remainder have a rugged nylon moulding securing the outed sleeve to the termination. These features improve both the durability and life expectancy of the antenna.

Each pre-tuned frequency has its own color coding making individual frequencies instantly recognisable. Helping you to ensure you have received the correct antenna.

## Part Numbering

There are many different combinations that can be made up for Panorama's portable antennas, there is a very easy way to get the right product.

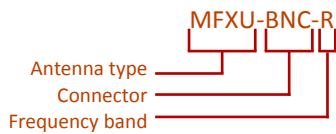

Connector	Antenna	Used by
BNC	MXK, PXX, MVQ, MFX, MQ, MFXU	All radios with BNC socket
ICF4	XPK, MFX, MQ, MFXU	ICOM with J type screw connector
ICF5	PXX, MFX, MFXU, MQ	ICOM IC-F51/61
ICF9	MFX, MFXU, MQ	ICOM IC-F9011/9021 & models with SMA
MX	MXK, PXX, MVQ, MFX, MQ, MFXU	KENWOOD, MAXON, MOTOROLA, TAIT 3000
MG	MXK, PXX, MVQ, MFX, MQ MFXU	MOTOROLA JEDI (GP900/GP2100/HT/MT SERIES) SIMOCO TSP
MV	MXK, PXX, MVQ, MFX, MQ MFXU	SIMOCO (SRP 1000/8000) MAXON SL1000/7000
PRP73	MXK, MFX, MFXU	SIMOCO, PRP73/76
SL100	PXX, MFX, MQ MFXU	MAXON (SL100)
SMAFR	PXX, MFX, MQ MFXU	KENWOOD (SMA)
SMAMO	MXK, MFX, MQ MFXU	TAIT (ORCA + 5000 SERIES)
TNC	MXK, PXX, MVQ, MFX, PUG, MQ MFXU	All radios with TNC socket
TNK	MXK, PXX, MVQ, MFX, MQ MFXU	GRUNDIG, KEY, KYODO
TNM	MXK, PXX, MVQ, MFX, MQ MFXU	KEY, KYODO
VX-410	PXX, MFX, MQ MFXU	ALL YAESU (except VX-450)

Disclaimer: Specifications are subject to change without notice. All trademarked names are used as reference only and belong to respective owners.



Part No.	MXK	PXX	MVQ	MFX	MFXU	MQ	PUG
Description	moulded compressed helical	soft compressed helical	moulded flexible quarterwave	moulded VHF helical	moulded UHF helical	moulded quarterwave	UHF halfwave
Frequency (banded)	67-88	141-225	141-336	141-366	330-512	330-512, 698-960	350-512
Length (inch)	7.68 @ 68MHz	3.25 @ 146MHz	19.69 @ 146MHz	6.69 @ 451MHz	2.84 @ 451MHz	6.14 @ 451MHz	13.39 @ 451MHz
Max Diameter (inch)	0.55	0.39	0.55	0.39	0.39	0.44	0.63

LPMM[B]-7-27 List: \$148.00

LGMM[B]-7-27 (GPS option) List: \$172.00

LPMM[B]-7-27-24-58 (WiFi option) List: \$172.00

LGMM[B]-7-27-24-58 (GPS & WiFi option) List: \$196.00

## LGMM/LPMM Range

Rugged low profile design available in black or white  
 2x Wideband LTE/Cellular elements  
 2x 2.4 & 4.9-6GHz WiFi/WiMAX Elements\*  
 Integrated GPS antenna\*

The Panorama LP[G]MM low profile MIMO antenna range has been designed to support the new generation of vehicular LTE routers.

The antenna enclosure contains up to five isolated high performance antenna elements; two ultra-wideband elements covering 698-2700MHz support MIMO/diversity at cellular/LTE frequencies and two dual band elements covering 2.3-2.7 & 4.9-6GHz support MIMO/diversity operation for WiFi and WiMAX. The LGMM also contains a high performance GPS antenna with an integrated 26dB gain LNA and high quality filtering to combat noise.

The antennas do not require a metallic ground plane, and maintain a high level of performance even when mounted on nonmetallic surfaces.

*Please enquire about equipment specific kits*

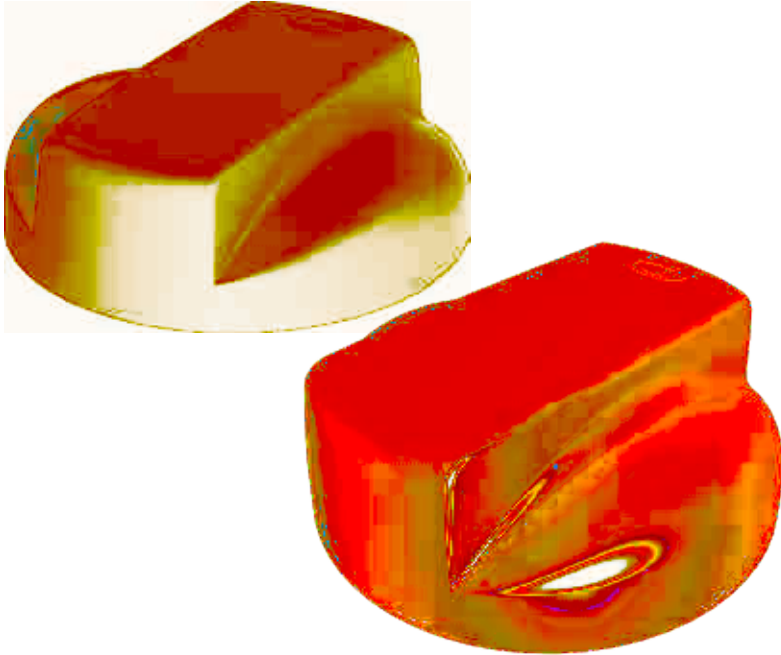

## Technical Drawing

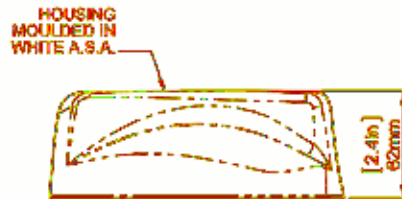
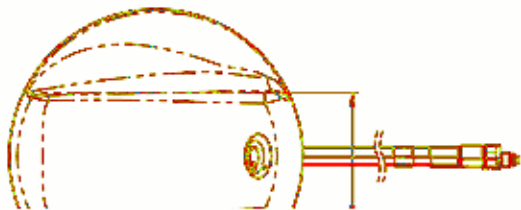

Part No.	What's Inside		
	2x Cellular	GPS	WiFi
LPMM[B]-7-27	✓	-	-
LGMM[B]-7-27	✓	✓	-
LPMM[B]-7-27-24-58	✓	-	✓
LGMM[B]-7-27-24-58	✓	✓	✓

Part No.		
LGMM-7-27-24-58		
Electrical Data		
Frequency Range (MHz)	Elements 1 & 2	698-960/1700-2700
	Elements 3 & 4	2.3-2.7/4.9-6GHz
Peak Gain: Isotropic (all bands)	Elements 1 & 2 -698-960	>0dBd
	Elements 1 & 2 -1700-2700	>3dBd
	Elements 3 & 4	0dBd
VSWR	Elements 1 & 2	< 2.5:1
	Elements 3 & 4	< 2:1
Isolation	Elements 1 & 2	> 15dB
	Elements 3 & 4	> 20dB
Impedance		50Ω
Max Input Power (W)		50
GPS Data		
Frequency Range (MHz)		1575
VSWR		<2.0:1 ± 4MHz
Gain: LNA		26dB
Polarization		Right Hand Circular
Operating Voltage		3 - 5V DC (fed via coax)
Current		Typical 15mA
Mechanical Data		
Dimensions	Height	2.4"
	Diameter	6.7"
Operating Temp		-40°/ 176°F
Material		ASA & die cast aluminium
Mounting Data		
Max panel thickness		0.236"
Mounting hole		3/4"
Cable Data		
GPS Cable	Type	RG174
	Termination	FME Female
Cell/LTE Cables x2	Type	CS29 (double shielded RG58)
	Termination	SMA plug
WiFi/WiMAX Cables x2	Type	26174
	Termination	SMA Female

\*selected models

LPB-7-27-05SP List: \$40.00

LPB-7-27-5SP List: \$44.80

LPB-7-27-5F List: \$44.80

Part No.			
	LPB-7-27-05SP	LPB-7-27-5F	LPB-7-27-5SP
<b>Electrical Data</b>			
Frequency Range (MHz)	698-960/1710-2700		
Peak Gain	0dBd/3dBd		
VSWR	<2.5:1		
Impedance	50Ω		
Max Input Power (W)	50		
<b>Mechanical Data</b>			
Operating Temp (°C)	-40°/+176°F		
<b>Cable Data</b>			
Length	1.6'	16'	16'
Termination	SMA plug	FME jack	SMA plug

## LPB-7-27 Series, LPB-7-27 Series

Rugged low profile design

Excellent bandwidth

Covers 4G LTE bands

The Panorama LPB low profile antenna range has been designed to perform under extreme pressure. At only 3.22" (82mm) high and protected by a robust high impact radome the antenna is almost impervious to daily wear, tear and impact.

The LPB offers excellent performance across a wide bandwidth. Mounted on a 15.7" x 15.7" ground plane the LPB covers public safety/LTE frequencies across 700 and 800MHz as well as 1710-2700MHz making it an extremely versatile product.

Supplied with a convenient adhesive pad, washer and a nut screw, it is cost effective to install and adaptable to any environment.

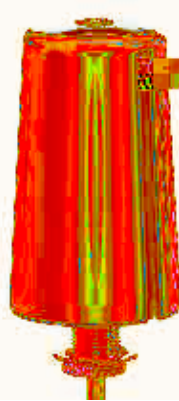

## Technical Drawing

AAAAAA AAAAA

AAAAA AAAAA

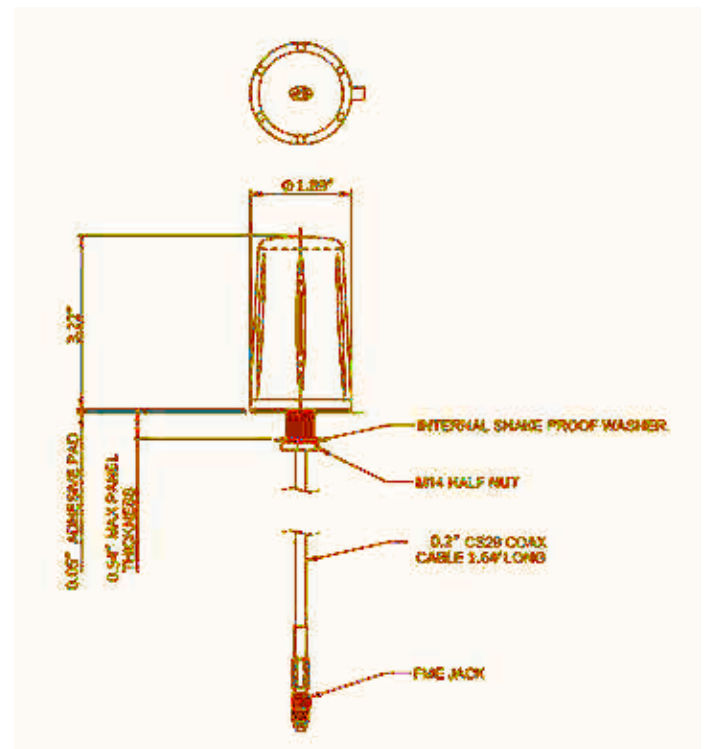
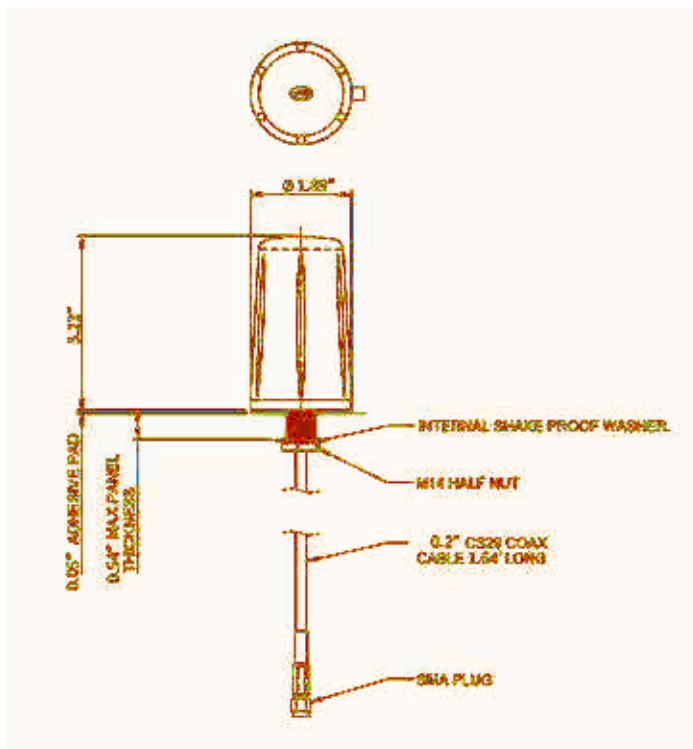

## LP460, LG460, LPL-S5, LGL-S5

LP460 List: \$109.20  
 LG460 List: \$142.80  
 LPL-S5 List: \$109.20  
 LGL-S5 List: \$142.80

Heavy duty application  
 Ground plane independent  
 Rugged design

The Panorama low profile antenna range has been designed to withstand high impacts while maintaining its functionality.

The antenna does not require a metallic ground plane, and maintains the same great performance when mounted on any surface.

An excellent solution for demanding applications in transportation.

The LG series is the GPS version of the LP series.



Part No.	LP460	LG460	LPL-S5	LGL-S5
<b>Electrical Data</b>				
Frequency Range (MHz)	450-470	450-470	805-870	805-870
Peak Gain	-2dBd	-2dBd	0dBd	0dBd
Impedance	50Ω	50Ω	50Ω	50Ω
Max Input Power (W)	50	20	50	50
GPS	No	Yes	No	Yes
<b>Mechanical Data</b>				
Total Height	1.6"	1.6"	1.3"	1.3"
Operating Temp (°F)	-40°/+158°F			
Fixing	Panel mount			
<b>Cable Data</b>				
Type	RG174	RG174	RG174	RG174
Comms Termination	FME plug	FME plug	FME plug	FME plug
GPS Termination	-	FME socket	-	FME socket

## Technical Drawing

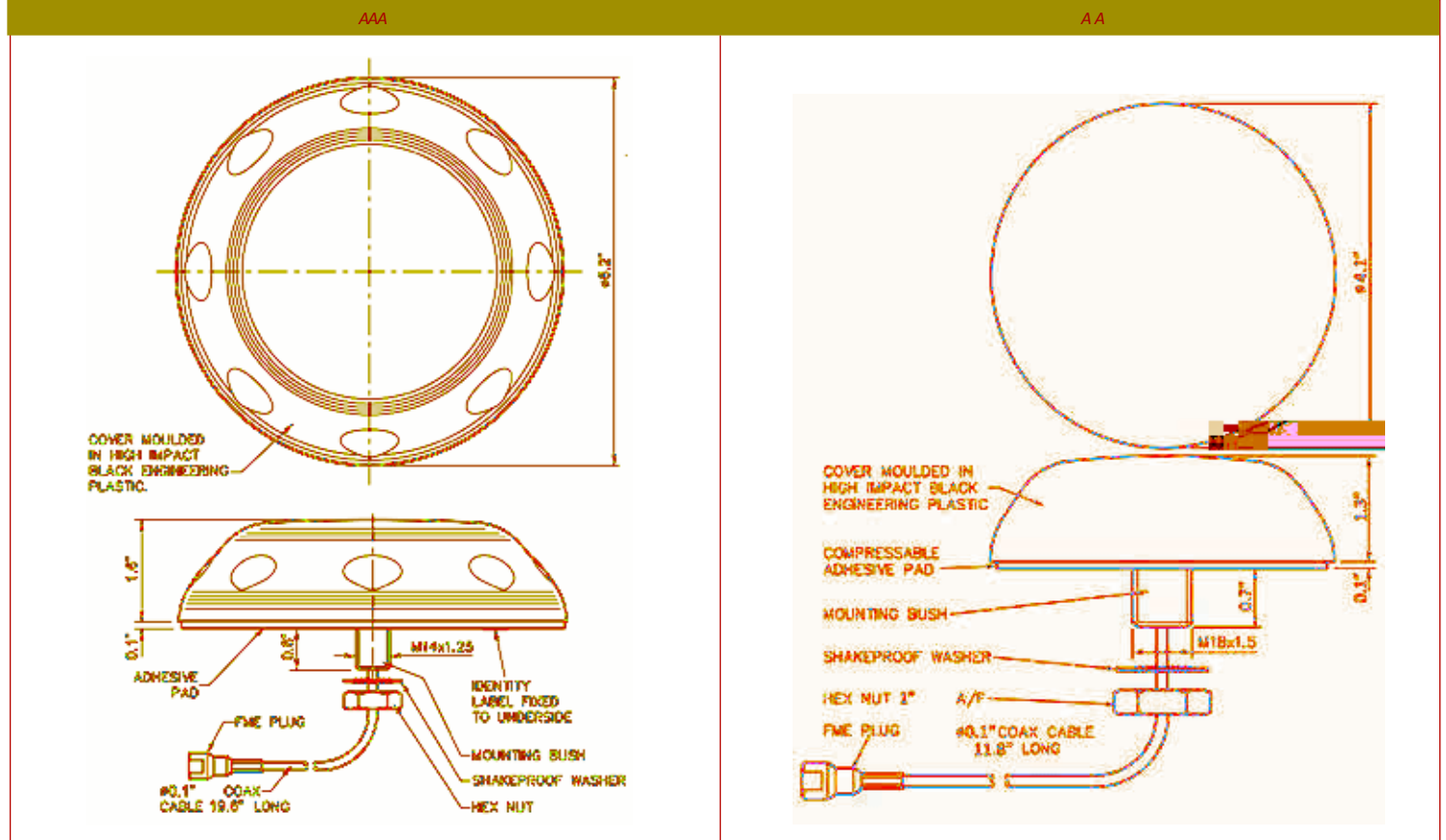

VCD-VH-5F List: \$143.20

VCD-S4-5F List: \$143.20

Part No.	VCD-VH-5F	VCD-S4-5F
<b>Electrical Data</b>		
Frequency Range (MHz)	130-175 (tuned)	450-470
Peak Gain	0dBd (unity)*	
Impedance	50Ω	
Max Input Power (W)	100	
<b>Mechanical Data</b>		
Operating Temp (°F)	-40°/+80°C (-40°/+175°F)	
<b>Cable Data</b>		
Type	CS23 (RG58 C/U)	
Length	16'	
Termination	FME Socket (female)	

\*In free space - gain will vary based on installation



## VCD-VH-5F, VCD-S4-5F

- Dipole construction
- Covert bumper mounting
- Flexible wire elements

This discreet vehicle dipole antenna is specifically designed for covert installations. With fully flexible dipole wire elements, installation is easy and versatile for applications where a completely covert antenna is required.

This specialist antenna is supplied uncut and should be tuned to the required band when fitted by cutting down the radiating elements, ensuring that a good VSWR match is achieved.

Two antennas can even be used with a power divider to maximise coverage.

## Technical Drawing

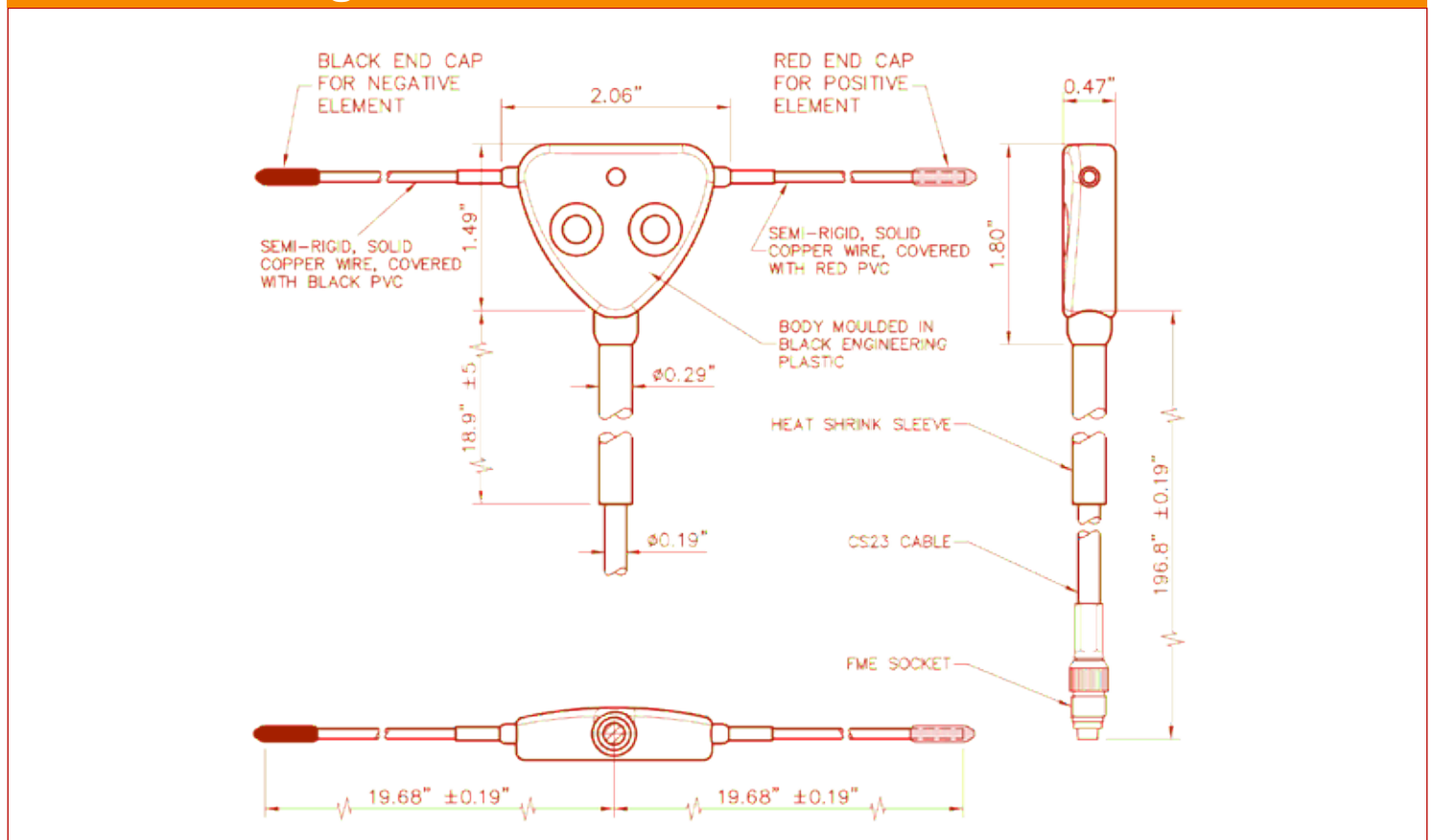



# BMP1 & BMP2

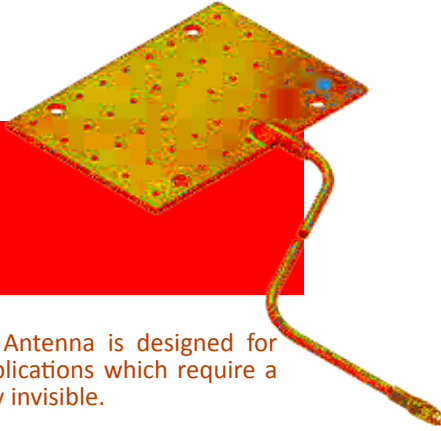

The Panorama Bumper Mount Antenna is designed for covert operations and other applications which require a vehicle antenna that is effectively invisible.

Mounted in the vehicle's bumper, installation requires no drilling and is invisible from the outside of the car.

For optimum performance two bumper antennas can be used, one at the front of the vehicle and one at the rear, to help create a more omnidirectional pattern around the vehicle and enable better network coverage. The BMP2 kits come complete with a power divider and 2 bumper mount antennas.

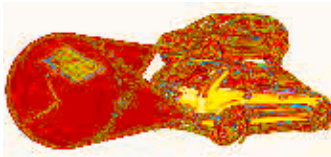

Antenna positioning

Electrical Data		
Peak Gain: Isotropic	Varies on installation	
Bandwidth @ 2:1 VSWR	5%	
Frequency Range (MHz)	410 - 470 (banded)	
Polarisation	Vertical	
Pattern	Omnidirectional	
Impedance	50Ω	
Max Input Power (W)	25 (5 for BMP2)	
Mechanical Data		
Operating Temp (°C)	-40°/+80°C (-40°/+175°F)	
Material	TPE	
Colour	Black	
Dimensions (inches)	Length	5.5
	Width	3.9
	Diameter	a

## Technical Drawing



# Covert Vehicle Antennas

# Internal On-Glass Antenna

EF-BC3G-26-3SP List: \$27.89

EF-460-3F List: \$27.89

EFBAD-3F List: \$27.89

EF-W24-2 List: \$27.89

EF-BC3G-26-3SP, EF-460-3F,  
EFBAD-3F, EF-W24-2

Part No.	EF-BC3G-26-3SP	EF-460-3F	EFBAD-3F	EF-W24-2
<b>Electrical Data</b>				
Frequency Range (MHz)	805-960/ 1710-2170/ 2396-2700	450-470	700-960	2400-2485
Peak Gain	0dBd	0dBd (unity)	0dBd(unity)	0dBd(unity)
Impedance	50Ω	50Ω	50Ω	50Ω
Max Input Power (W)	25	40	30	10
<b>Mechanical Data</b>				
Operating Temp (°F)	-22°/+158°F	-40°/+175°F	-40°/+175°F	-40°/+175°F
<b>Cable Data</b>				
Length	10'	9.8'	9.8'	6.5'
Termination	SMA Plug	FME socket	FME socket	Bare end



Covert application  
No-hole installation  
Can be removed without a trace

The EF 'easy fit' antenna range are efficient, versatile, compact & covert.

The EF antenna range are extremely low profile, with a flexible body for installation on uneven surfaces, allowing huge versatility for the installer. The antenna comes complete with a secure industry grade adhesive pad, making installation quick and simple. The antenna can also be removed without any damage to the install site.

## Technical Drawing

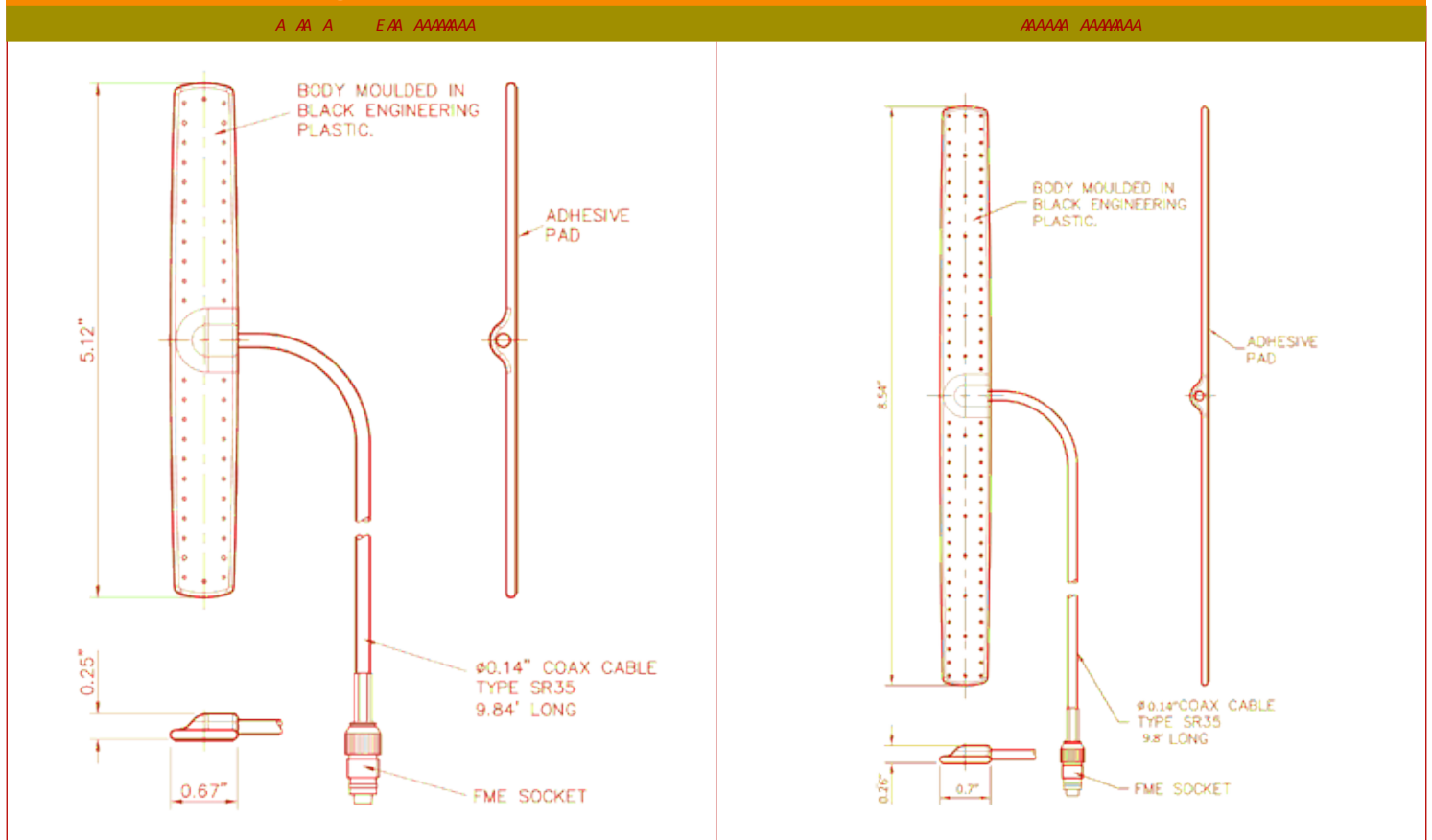

## TRNB & TRNBG

TRNB List: \$252.00  
TRNBG List: \$296.00

Standard four hole rail fixing  
Waterproof N connector  
Suitable for overground & underground trains

The TRNB antenna series is designed specifically for use on trains; underground or over ground. With an omnidirectional peak gain of over 3dBd, the TRNB series covers either 400MHz or 7/800MHz bands along with multiband GSM, GSM-R, 3G UMTS & 2.4GHz WLAN and has the option of a GPS antenna.

Housed in a UV stabilised, flame retardant Lexan housing, the TRNB series is fully weatherproof ensuring the antenna's performance is never compromised even when subjected to industrial carriage wash systems.

The TRNBG series also incorporates a GPS module with 26dB gain.

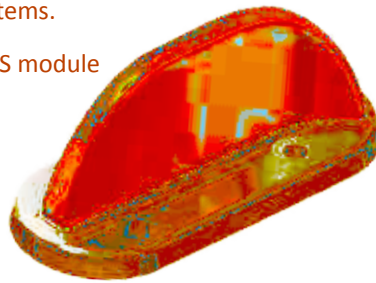

Part No.		
Without GPS	TRNB-S4	TRNB-7-27
With GPS	TRNBG-S4	TNBG-7-27
Electrical Data		
Frequency Range (MHz)	450-470	698-960/1700-2700
Peak Gain	3dBd	3dBd
Impedance	50Ω	
Max Input Power (W)	100	
Mechanical Data		
Total Height	4"	
Operating Temp (°F)	-40°/+175°F	
Connector Data		
Termination	N socket (female) (comms) & SMA socket (female) (GPS)	

## Technical Drawing

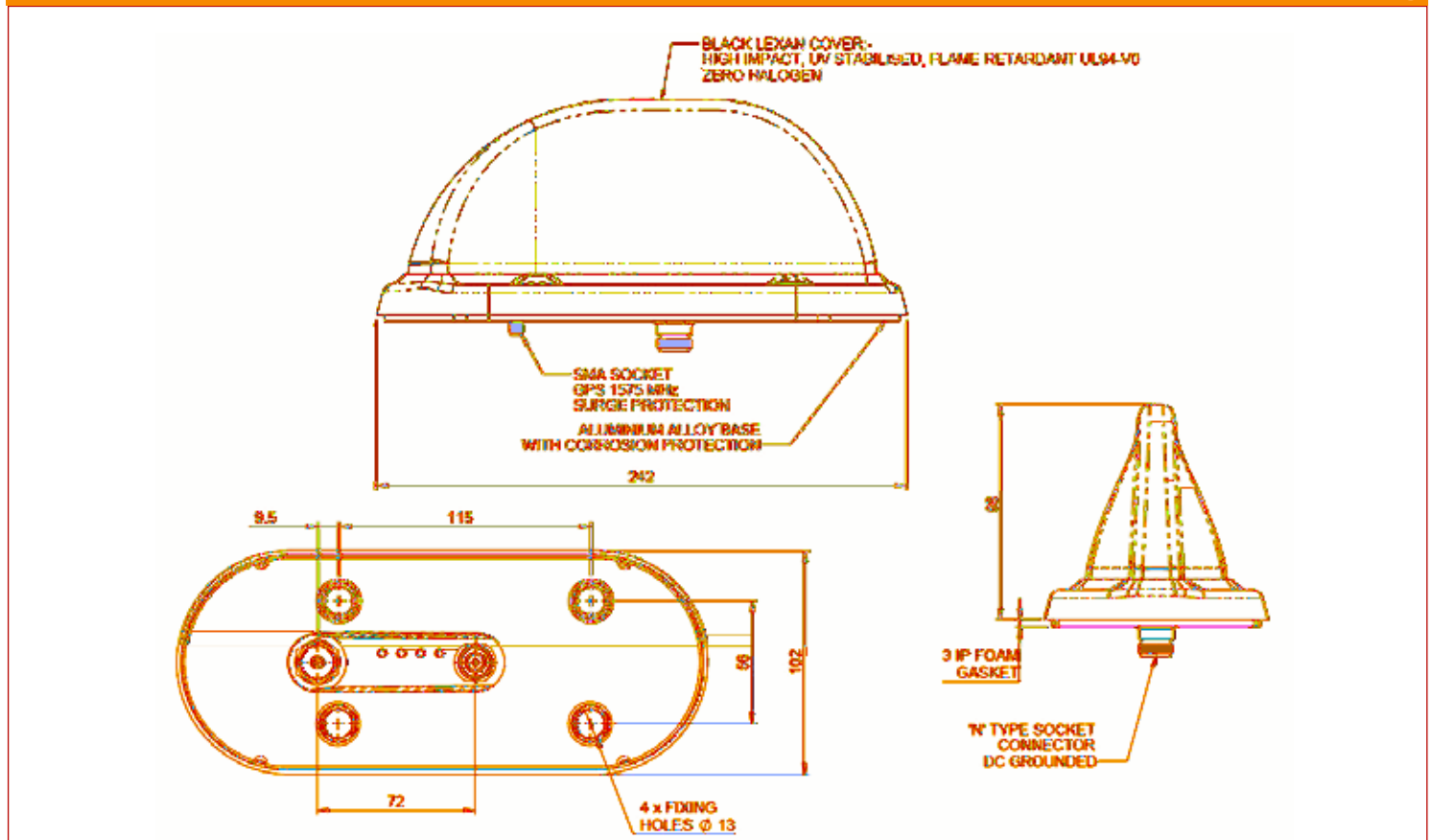

# Fixed Site Antennas

# Elevated Antennas

BS800 List: \$144.48

BS-IN1766 List: \$147.20

BSU-S4 List: \$144.48

Part No.	BS800	BS-IN1766	BSU-S4
<b>Electrical Data</b>			
Frequency Range (MHz)	762-870	139-168	450-470
Peak Gain	3dBd	0dBd (unity)	0dBd (unity)
Bandwidth @ 2:1 VSWR	10%		
Impedance	50Ω		
Max Input Power (W)	100		
<b>Mechanical Data</b>			
Operating Temp (°F)	-40°/+175°F		-22°/176°F
<b>Termination Data</b>			
Termination	N socket (female)		

Note: Cable sold separately

## BS800, BS-IN1766, BSU-S4

Mast mount

Temporary or permanent fixing

Control station, base station

Panorama elevated Antennas can be used for temporary field use or permanent installations. The range uses flexible elements to provide an effective but compact ground plane.

The antenna's centre fitting has a metal hub to mount the radials and a moulded insulator for the radiator. The whip element is plastic coated to make it weather proof and durable.

An N socket connector is fitted to enable a wide range of coaxial cable types to be used.

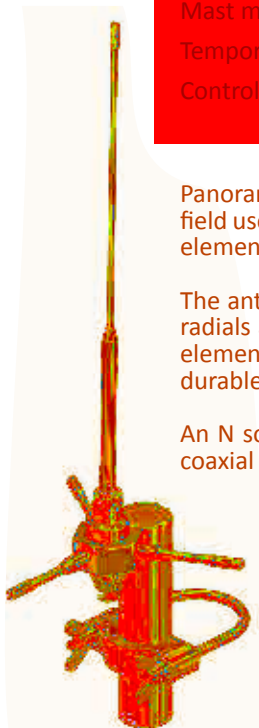

## Technical Drawing

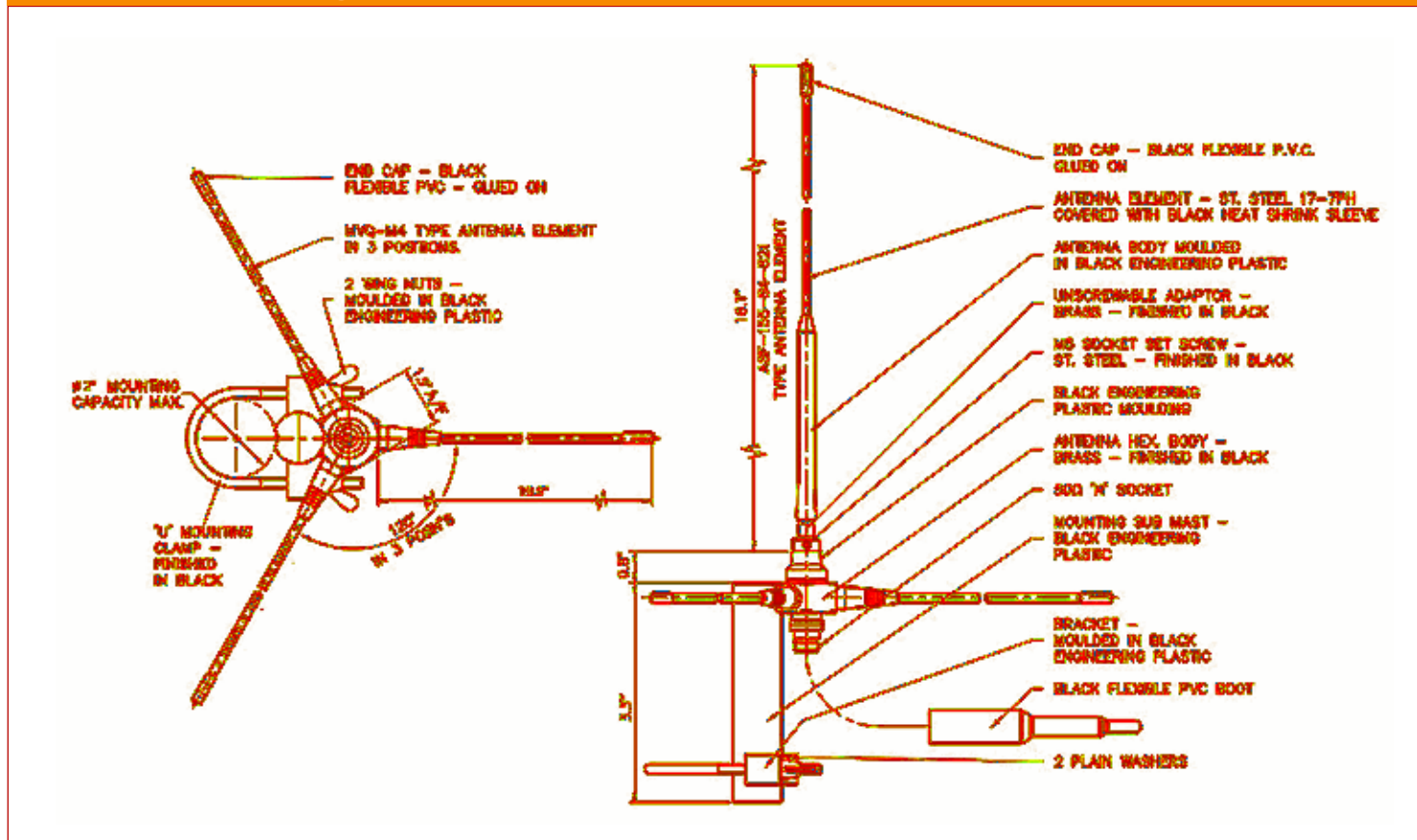

## CDV & CDU Range

CDV List: \$104.80

CDU List: \$97.44

Temporary applications

Portable

Easy installation

The performance and scope of portable equipment can often be considerably improved by extending the antenna to a more efficient height. Spring clip antennas provide an easy way to do this.

The jaws of the spring clip are moulded in nylon and are fully adjustable for any angle. The antenna features a fully moulded coaxial connection for weather protection and resilience.



Part No.	CDV-H5	CDV-H6A	CDU-S4	CDU-U2
<b>Electrical Data</b>				
Frequency Range (MHz)	149-159	155-174	450-470	450-512
Gain	0dBd			
Bandwidth @ 2:1 VSWR	12%			
Impedance	50Ω			
Max Input Power (W)	100			
<b>Mechanical Data</b>				
Operating Temp (°F)	-40°/+175°F			
<b>Cable Data</b>				
Length	16'			
Termination	Bare end cable			

Other frequencies available: to see the full band plan see page 48.

## Technical Drawing

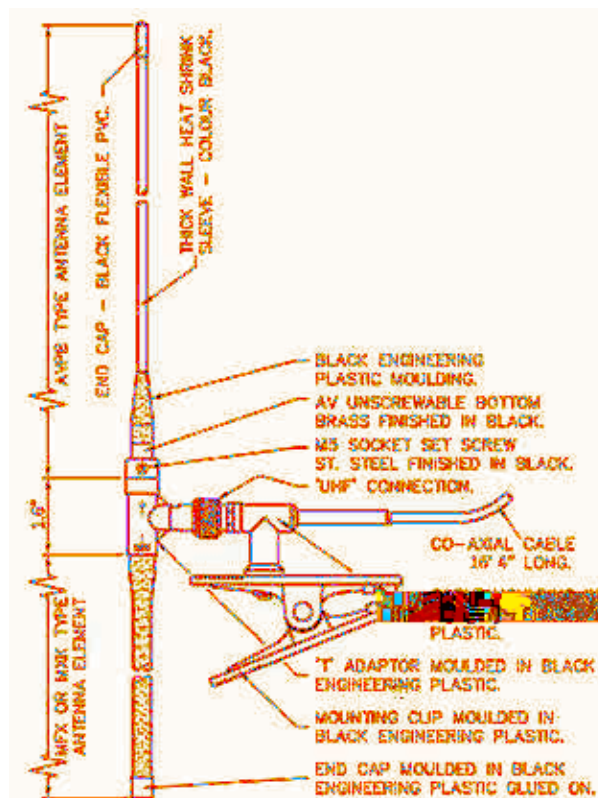

GPSME-6SP List: \$47.04

GPSP-F List: \$67.20

Part No.	GPSME-6SP	GPSP-F
<b>Electrical Data</b>		
Frequency Range (MHz)	1575	1575
Peak Gain	26dB	26dB
Impedance	50Ω	
<b>Mechanical Data</b>		
Operating Temp (°F)	-40°/+175°F	
<b>Cable Data</b>		
Type	RG174	
Termination	SMA Plug (male)	FME socket

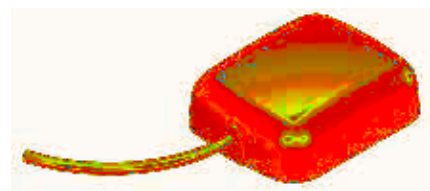

GPSME-6SP

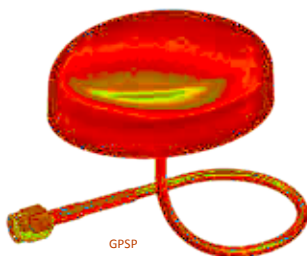

GPSP

## GPSME-6SP, GPSP-F

Excellent performance  
Active GPS element

The GPSME-6SP offers GPS and cellular coverage in a small, and discreet device. Mounting is totally flexible with a unique 'either way up' mounting system enabling easy positioning of the antenna under or on any non-metallic surface.

The GPSP panel mount antenna offers high performance GPS in a discreet, low profile housing. Mounted on the roof of a vehicle with single hole installation, the GPSP provides optimal performance while it's low profile design reduces the risk of damage.

With the GPSP, complete tracking for fleet management or logistics planning is possible with the reassurance of a dependable high quality unit in all your vehicles.

## Technical Drawing

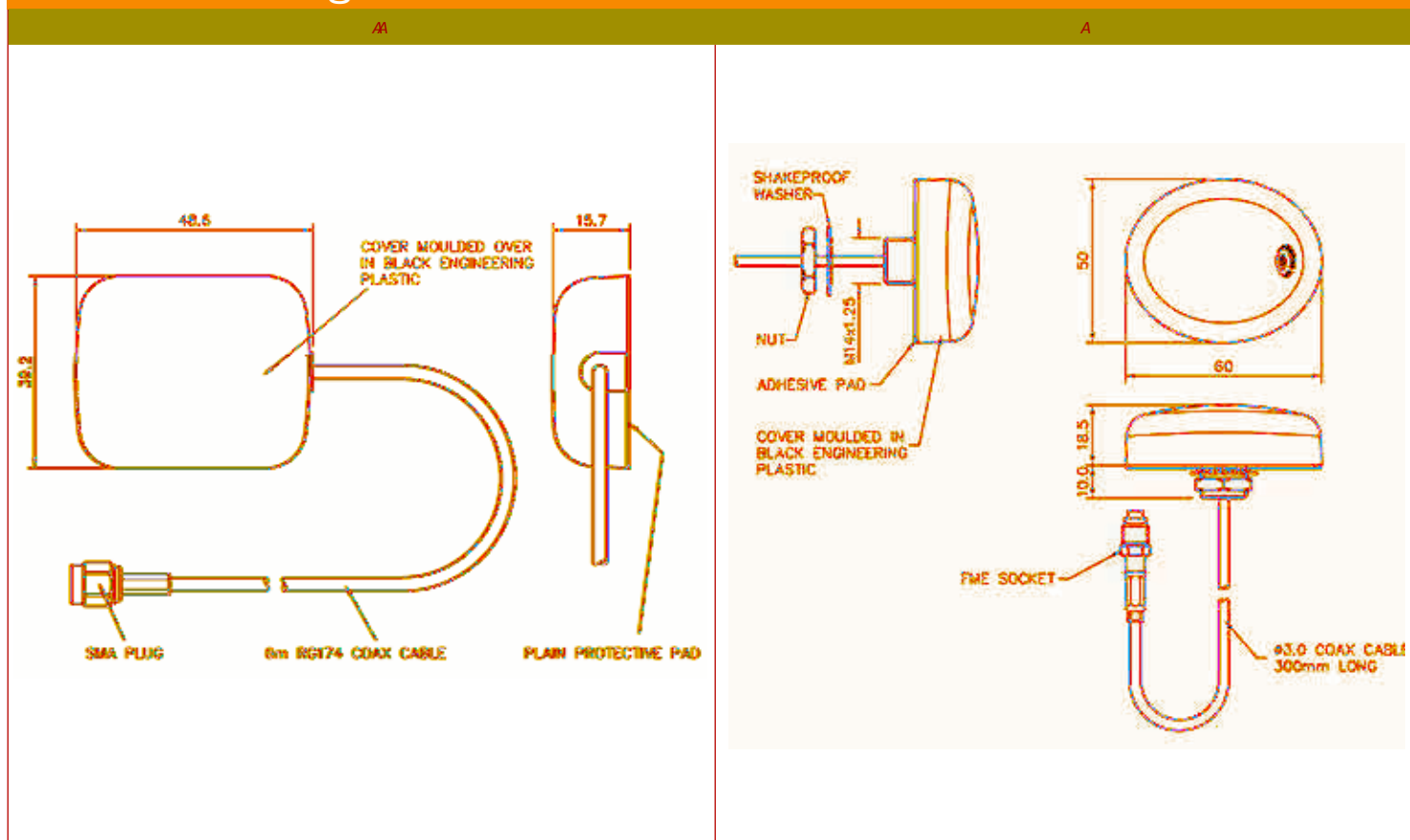

## SAB-071B

List: \$9.25

Replacement adaptor for the M8 base



## KRV393 & KRV391

List: \$12.77

Replacement kits for glass mount antennas

KRV393 - For VHF & GSM

KRV391 - For UHF

## IN1922

List: \$12.77

Replacement kit GPSB Sharkee® antennas



## SAB-070HB

List: \$9.25

Replacement hinged adaptor for the M8 base

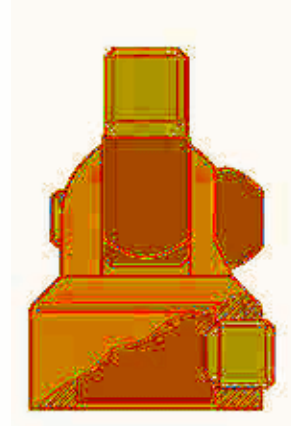

### FOOT AND HINGE ASSEMBLY

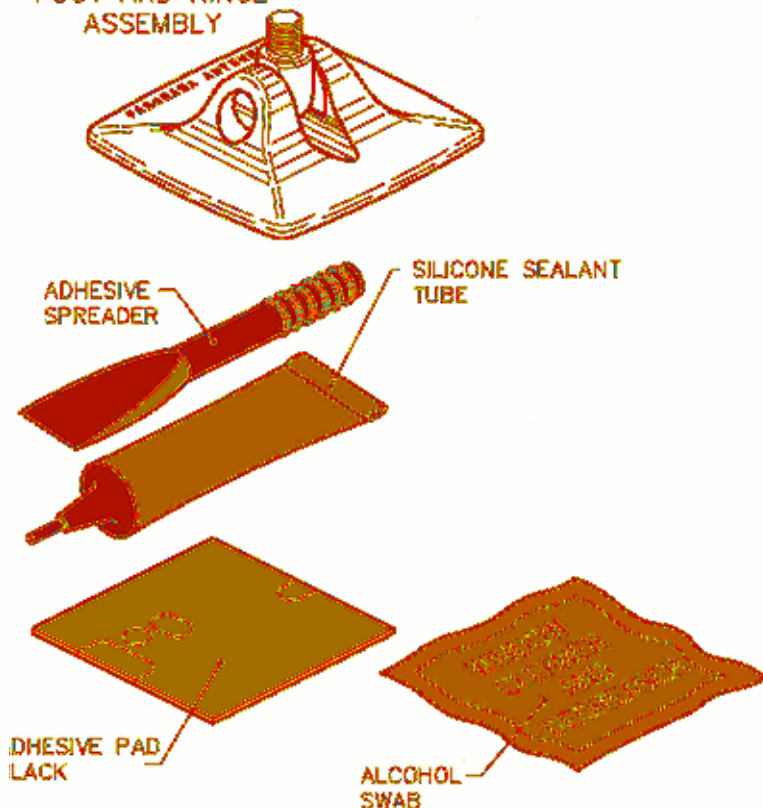

DPXA-BC-160-SMBJ List: \$235.20

Part No.		
DPXA-BC-160-SMBJ		
Electrical Data		
Frequency Range (MHz)	87.5-108 / 160-1700	
Insertion Loss	< 0.5dB	
Amplification (FM)	>16dB	
Current	Typical 16 mA	
Operation Voltage	12V (DC)	
Mechanical Data		
Operating Temp (°F)	-22° /+158° F	
Material	Aluminium	
Colour	Grey	
Termination	DC power	6, 3 Din 16310 (f)
	Antenna	FME (M)
	Comms	FME (M)
	FM Radio	SMB Jack (male)

## DPXA-BC-160-SMBJ

Splits and amplifies FM from standard whip

The DPXA-BC-160 allows professional users to swap out factory fit antenna systems but retain FM radio coverage.

When used with a compatible Panorama whip the DPXA-BC-160 splits off and amplifies FM from the standard whip feed ensuring that a professional antenna installation doesn't have to mean a loss of FM coverage.

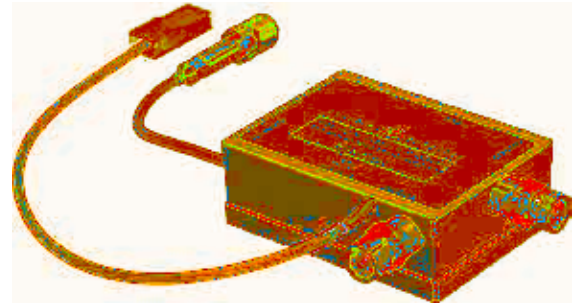

## Technical Drawing

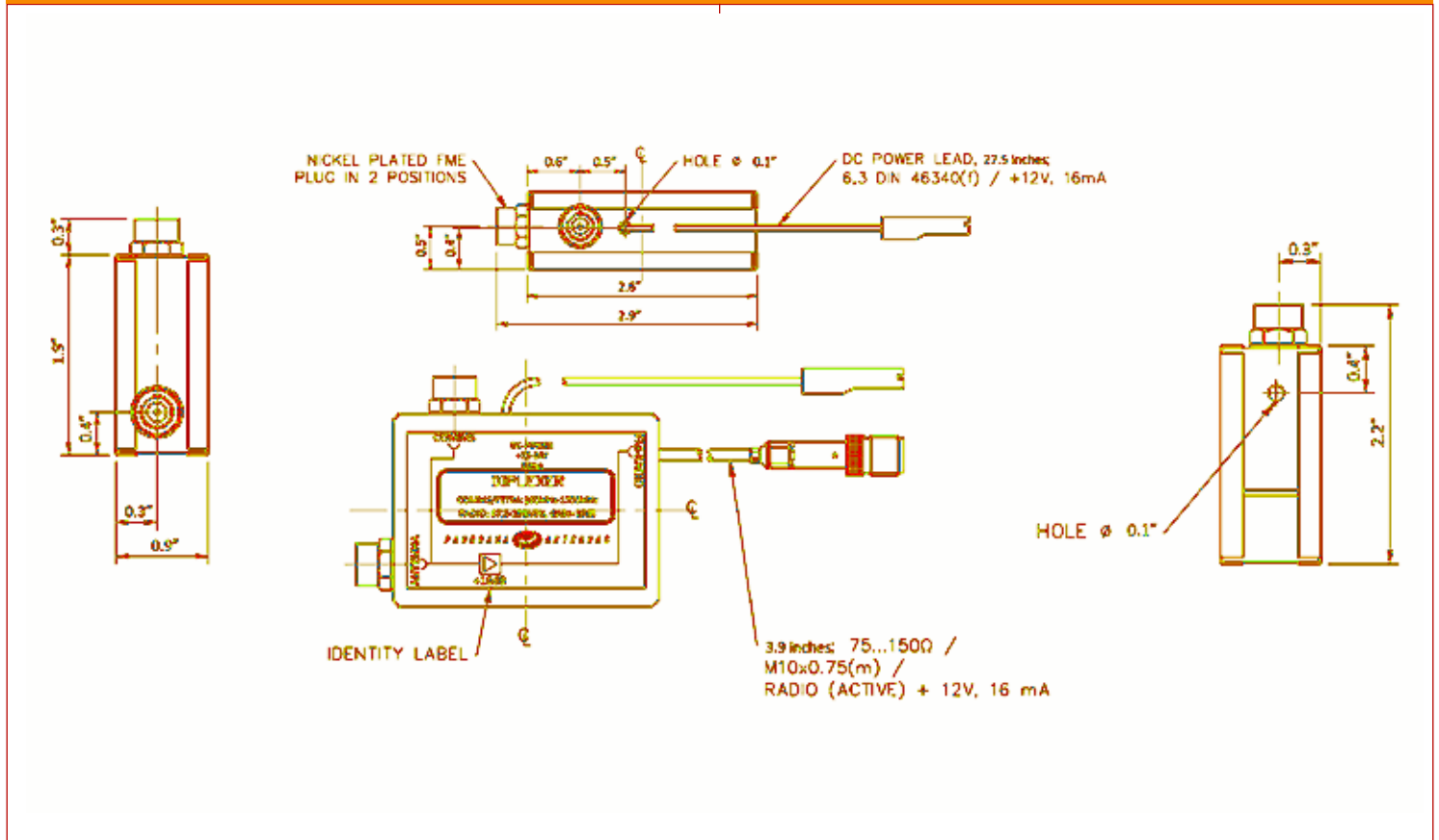



## DPX-500-700, DPX-210-270

DPX-500-700 List: \$220.00

DPX-210-270 List: \$220.00

Use one antenna for two radios  
VHF & UHF

The Panorama diplexers, can either combine the signals from two antennas to a single multiband radio or split the signal from a dual band antenna to two separate radios. There is no need for switching or matching as the DPX will automatically split or combine UHF and VHF to route them to their separate radios.

This compact unit requires no power cables and can easily be installed in the roof lining of any vehicle or mounted next to the radio.

The DPX is ideal for all dual band and VHF/UHF migration systems.



Part No.		DPX-500-700	DPX-210-270
<b>Electrical Data</b>			
Frequency Range (MHz)	VHF	50 - 500	50 - 210
	UHF	700 - 2500	270 - 1000
Insertion Loss	VHF	< 1dB	< 1dB
	UHF	< 1dB	< 1dB
Insertion between high and lowpass ports		> 40dB	> 40dB
Maximum input power		100 Watts	100 Watts
<b>Mechanical Data</b>			
Operating Temp (°C)		-40°/+175°F	40°/+175°F
Material		Aluminium	Aluminium
Color		Black	Black
Termination		FME sockets on all ports	FME sockets on all ports
<b>Mounting Data</b>			
Fixing		4 × Mounting holes	4 × Mounting holes

## Technical Drawing

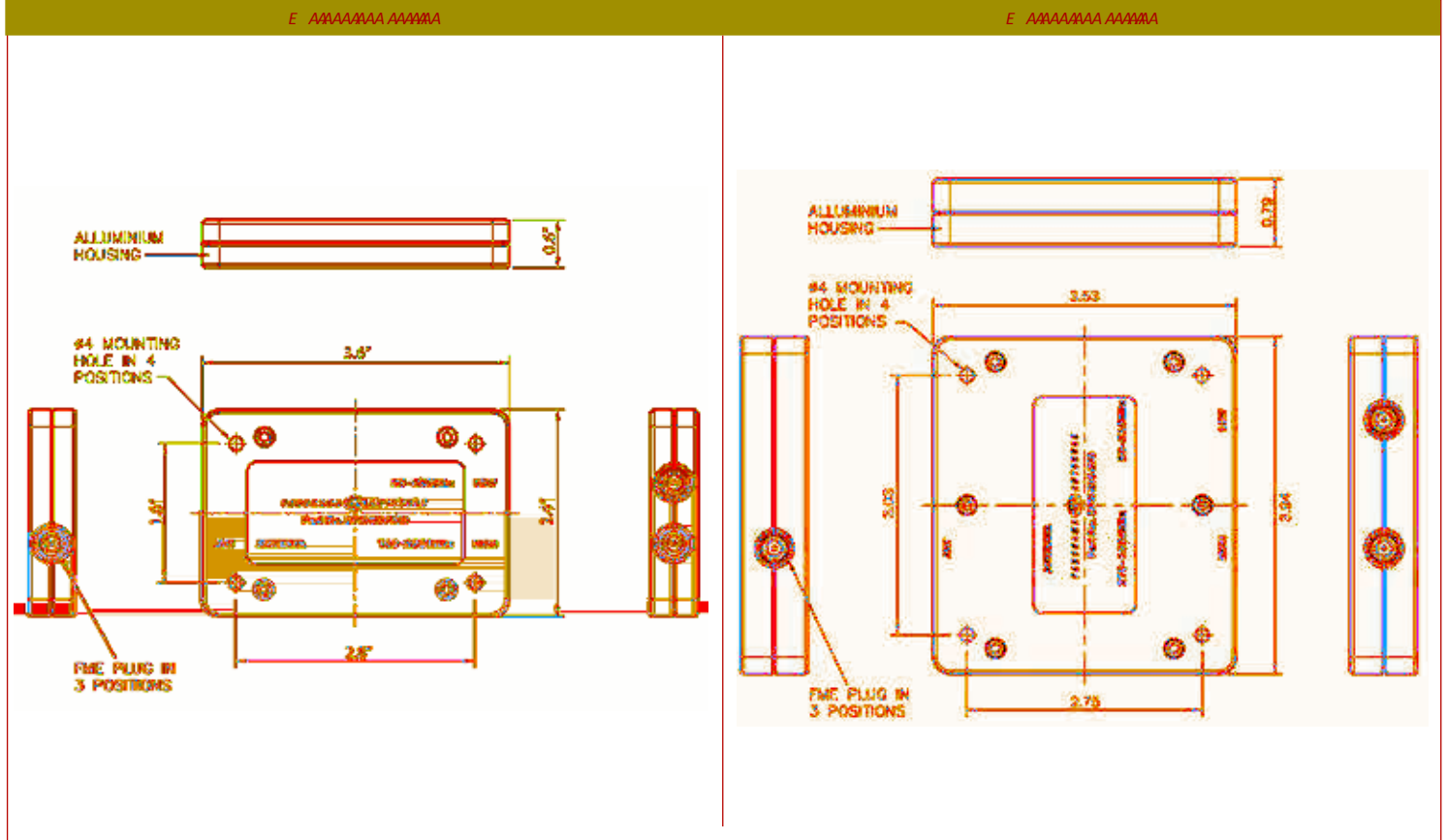

DPD-GPS List: \$120.00

QPD-GPS List: \$282.40

Part No.	DPD-GPS	QPD-GPS
<b>Electrical Data</b>		
Frequency Range (MHz)	1575	1000-2000
Insertion Loss	< 0.5dB	< 0.6dB
Isolation between GPS ports	> 15dB	> 22dB
Maximum input power	25 Watts	10 Watts
DC feed voltage	Fed via Rx1 Port	10V (max)
<b>Mechanical Data</b>		
Operating Temp (°F)	-22°/+175°F	-22°/+175°F
Material	Aluminium	Aluminium
Termination	FME plugs on all ports	SMA Jack on all ports
<b>Mounting Data</b>		
Fixing	2 × Mounting holes	

## DPD-GPS, QPD-GPS

Optimise antenna performance

Run multiple GPS receivers from a single antenna

The Panorama DPD-GPS and QPD-GPS allow you to run two GPS receivers from only a single antenna. The DPD-GPS splits the received signal from the antenna to two receivers while only allowing one of the receivers to feed voltage to the antenna ensuring that the antenna is able to function correctly. The QPD-GPS has ports for 4 receivers.

The DPD-GPS and QPD-GPS are perfect for ensuring that multiple compatible GPS receivers can be used in the same vehicle with the minimum number of antennas thereby reducing clutter and installation costs.



The DPD-GPS and QPD-GPS split the received signal from a single antenna so it is important to confirm the signal requirements of the receiver's equipment before use.

## Technical Drawing

E EA AAAAAA

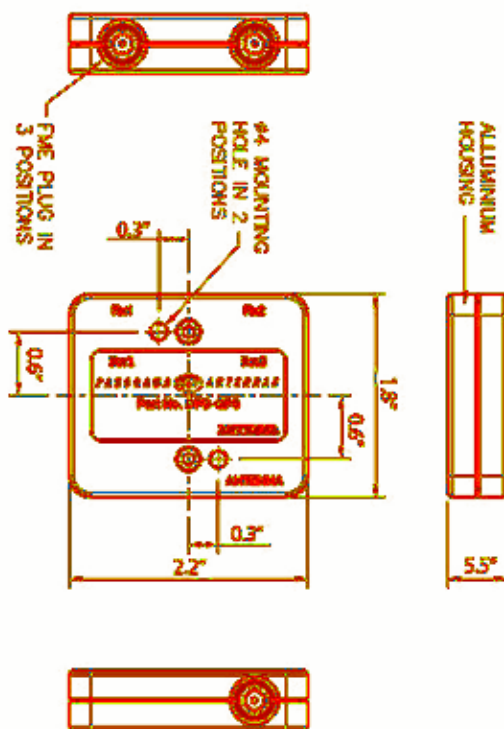

E EA AAAAAA

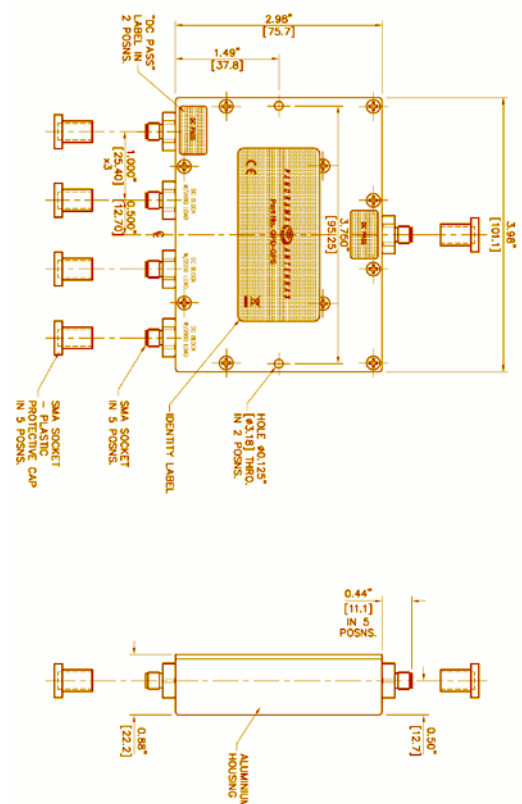

## TPX-VH-UHF-BA-TNC

TPX-VH-UHF-BA-TNC List: \$720.00

Low insertion loss, high port-to-port isolation  
 Use one antenna for 3 radios  
 VHF, UHF, 7/800MHz

The Panorama triplexer, TPX-VH-UHF-BA-TNC can either combine the signals from three antennas to a single multiband radio or split the signal from a tri-band antenna to three separate radios. There is no need for switching or matching as the TPX-VH-UHF-BA-TNC will automatically split or combine UHF and VHF to route them to their separate radios.

This compact unit requires no power cables and can easily be installed in the roof lining of any vehicle or mounted next to the radio. It is ideal for tri-band and multifrequency installations.

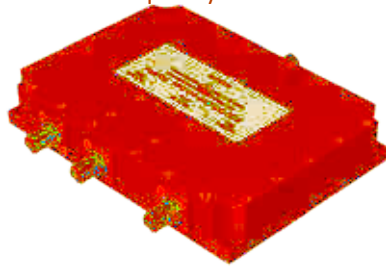

Electrical Data		
Frequency Range (MHz)	VHF	136-174
	UHF	380-520
	7/800	760-896
Insertion Loss	VHF	< 1dB
	UHF	< 1dB
	7/800	< 1dB
Isolation between ports		> 55dB
Maximum input power		100 Watts
Mechanical Data		
Operating Temp (°F)		-4°/+158°F
Material		Aluminium
Color		Black
Termination		TNC sockets on all ports
Mounting Data		
Fixing		4 × Mounting holes

## Technical Drawing

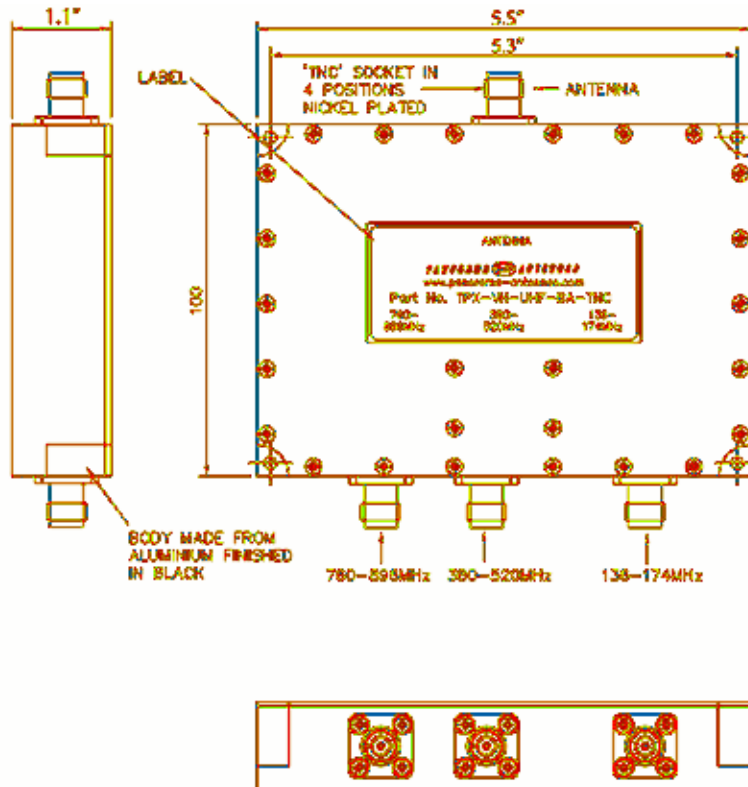

# Adaptors & Connectors

## FME adaptors



Part No.	CA-BP-FP	CA-FP-FP	CA-MP-FP
<b>Connector Data</b>			
Termination 1	BNC Plug (male)	FME Plug (male)	Mini-UHF Plug (male)
Termination 2	FME Plug (male)	FME Plug (male)	FME Plug (male)
Price	\$3.15	\$3.15	\$3.15

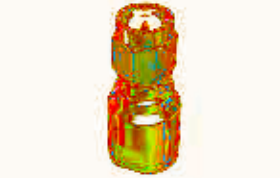

Part No.	CA-NP-FP	CA-PLP-FP	CA-SP-FP
<b>Connector Data</b>			
Termination 1	N Plug (male)	PL259 Plug (male)	SMA Plug (male)
Termination 2	FME Plug (male)	FME Plug (male)	FME Plug (male)
Price	\$12.77	\$3.15	\$3.15



Part No.	CA-TP-FP	CA-FJ-FJ
<b>Connector Data</b>		
Termination 1	TNC Plug (male)	FME Jack (female)
Termination 2	FME Plug (male)	FME Jack (female)
Price	\$3.15	\$5.22

## Crimp Connectors for RG58 and Panorama CS23 & CS29

Part No.	SC1-BNC-PC10	SC1-FME-PC10	SC1-FME-JC10	SC1-MPL-PC10	SC1-N-PC10
<b>Connector Data</b>					
Termination	BNC Plug (male)	FME Plug (male)	FME Socket (female)	Mini-UHF Plug (male)	N Plug (male)
Price	\$3.54	\$3.54	\$3.54	\$3.54	\$7.57

Part No.	SC1-SMA-PC10	SC1-TNC-PC10	SC1-UHF-PC10	SC1-N-JC10
<b>Connector Data</b>				
Termination	SMA Plug (male)	TNC Plug (male)	PL259 Plug (male)	N Female
Price	\$5.22	\$5.22	\$5.22	\$12.77

# Pigtails/Patch Leads



Part No.	C74-FP-015-CRC9	C74-FP-015-MCLP	C74-FP-015-MOBP	C74-FP-015-R151
<b>Connector Data</b>				
Cable type	RG174	RG174	RG174	RG174
Length	6"	6"	6"	6"
Termination 1	FME Plug (male)	FME Plug (male)	FME Plug (male)	FME Plug (male)
Termination 2	CRC9 Plug (male)	MCL Plug (male)	Moebius Plug (male)	RA 151 plug (male)
Price	\$15.87	\$15.87	\$24.27	\$15.87



Part No.	C74-FP-015-R281	C74-FP-015-RMCP	C74-FP-015-RMCPX	C74-FP-015-RMMCX
<b>Connector Data</b>				
Cable type	RG174	RG174	RG174	RG174
Length	6"	6"	6"	6"
Termination 1	FME Plug (male)	FME Plug (male)	FME Plug (male)	FME Plug (male)
Termination 2	R281 Plug (male)	RA MC Plug (male)	RA MCX Plug (male)	RA MMCX Plug (male)
Price	\$15.87	\$15.87	\$15.87	\$15.87



Part No.	C74-FP-015-RSSMBP	C74-FP-015-SMAP	C74-FP-015-TS9S	C74-SJ-010-TS9S
<b>Connector Data</b>				
Cable type	RG174	RG174	RG174	RG174
Length	6"	6"	6"	4"
Termination 1	FME Plug (male)	FME Plug (male)	FME Plug (male)	SMA Jack (female)
Termination 2	SSMB Plug (male)	SMA Plug (male)	TS9 Plug (male)	TS9 plug (male)
Price	\$15.87	\$15.87	\$15.87	\$15.87

# The best cable on the market?

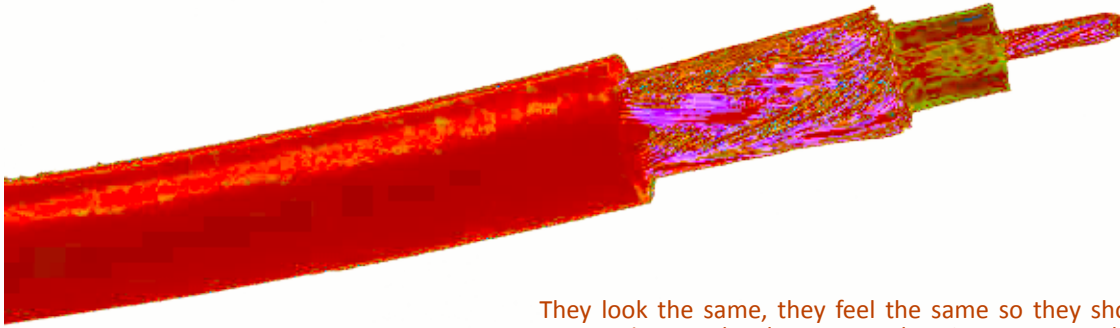

They look the same, they feel the same so they should work the same. This sort of assumption can be dangerous when it comes to selecting cable, as the coaxial cable from the antenna to the radio can make all the difference when it comes to an efficient system.

The Panorama Antennas low loss cable is designed to the highest specification with the radio installer in mind. The inner conductor consists 7 copper strands resulting in an easy vehicle installation due to its flexibility and a lower risk of fracturing or breaking in cold weather like some solid core alternatives. With the addition of a high performance polythene dielectric this ensures low attenuation and consistent impedance characteristics and the outer copper braid ensures a 93% coverage thanks to its 16/6 cross linked construction. This makes it the highest standard entry level cable on the market.

Cable Type	Attenuation (dB/meter)					
	800MHz	900MHz	1800MHz	1900MHz	2000MHz	2400MHz
RG174	1.00	1.10	1.45	4.50	1.55	1.70
CS23	0.47	0.54	0.80	0.85	0.88	1.0
CS29	0.35	0.37	0.54	0.57	0.59	0.65
CS32	0.35	0.37	0.54	0.57	0.59	0.65
CS400	0.12	0.13	0.18	0.19	0.20	0.22
MAAAAS-AA	0.70	0.75	1.10	1.12	1.30	1.60

## Key Cables

### CS23 Cable - (RG58 C/U)

CS23 cable is trusted by public safety across the world as a cost effective yet high performance cable. The cable offers a stranded centre conductor for extra flexibility and a high performance dielectric which out performs standard RG58.

### RG174 Cable

RG174 cable is a highly flexible solution and is available as kits for most GPS engines.

### CS29 Cable

With two layers of shielding to minimize attenuation and a stranded centre conductor to maximize flexibility, CS29 is the perfect low loss cable for frequencies up to 3GHz

### CS32 Cable

To maintain performance at high frequency Panorama offers CS32 cable. Featuring a solid centre conductor, high performance dielectric material and two layers of shielding, CS32 offers excellent performance up to 6GHz. This cable can be supplied with SMA Reverse Polarity SMA or other common connectors.

# Frequency Band Plan

Frequency (MHz)	Band
67-74	E3
74-81	E4
81-88	E5
132-143	H3
138-155	H4A
139-157	JRC
141-151	H4
149-159	H5
155-174	H6A
156-162	H6
162-174	H7
174-192	K5
192-208	K6
208-225	K7
220-250	L
245-275	M
270-300	N
300-334	R1
300-336	P
330-336	R
350-370	R2
350-392	S
380-400	S1
380-410	S1+
380-420	S3

Frequency (MHz)	Band
380-430	TET
390-432	T
400-430	T1
410-430	S2
410-470	U1
420-456	T2
430-472	U
450-470	S4
450-512	U2
470-512	W
500-520	W2
746-806	B1
806-870	S5
698-806	700MHz LTE
824-894	AMPS/CDMA850
890-960	GSM900
1575	GPS
1710-1882	GSM1800
1710-2155	AWS
1850-1990	PCS1900
1900-2170	3G/UMTS
2100-2170	3G UMTS
2110-2155	AWS
2400-2485	BLUETOOTH/WLAN
2394-2696	WiMAX/LTE 2.6
4900-5900	WiMAX/WiFi

# Customer Order Form

## Contact Information

Company Name	
First Name	
Last Name	
Title	

Sales Rep	
-----------	--

Company Acct. Number	
----------------------	--

## Billing Information

Email		
Address Line 1		
Address Line 2		
City		
State		Zip
Phone		
Fax		
Website		

Purchase Order Number	
-----------------------	--

## Customer Category

Dealer  SMEU  Other

## Payment

Net 30  Credit Card  C.O.D

## Shipping Information

Same as billing Address

Address Line 1	
Address Line 2	
City	
State	Zip

Shipping Preference	
---------------------	--

Part Number	Description	Quantity	Price



# Credit Application Form

## Contact Information

Company Name	
Contact Name	
Address Line 1	
Address Line 2	
City, State, Zip	
Phone	
Fax	
Email	

## Billing Information

A/P Contact Name	
Address Line 1	
Address Line 2	
City	
State	
Zip	

## General Company Information

Business Type	
Federal Tax ID Number	

In Business Since	
Principal Officer	
Title	

## Legal Structure

Corporation  Partnership  LLC  LLP  Sole Proprietor  Non-Profit

## Bank References

Bank Name	
Address Line 1	
City	
State	Zip

Bank Contact Name	
Phone	
Bank Account	

## Trade References

#1 Company Name/Contact/Phone	
#2 Company Name/Contact/Phone	
#3 Company Name/Contact/Phone	

In making this application for credit we authorize our bank and trade references to furnish Panorama Antennas Inc. and/or Panorama Antennas Ltd. with the information relating to our financial relationship with them. We hereby hold them harmless for any information they so provide. A fax copy or e-mailed copy of this signed authorisation is considered valid in making this application binding. We acknowledge and agree to Panorama Antennas Inc.'s terms of sale, and further agree that such terms of sale are not changed by any note to the contrary on any purchase order or through other official communication.

If approved, terms of sale are NET30 from invoice date. In the event of non-payment, late or incomplete payment per terms, we agree to pay interest at the rate of 1.5% per month (18% per annum), until invoice(s) are paid in full.

(Authorized Signature & Date)

Panorama Antennas Inc.  
1551 Heritage Parkway - Suite 101  
Mansfield TX, 76063-8333



Tel: 817-539-1888 Fax: 817-539-1881  
www.panorama-antennas.com

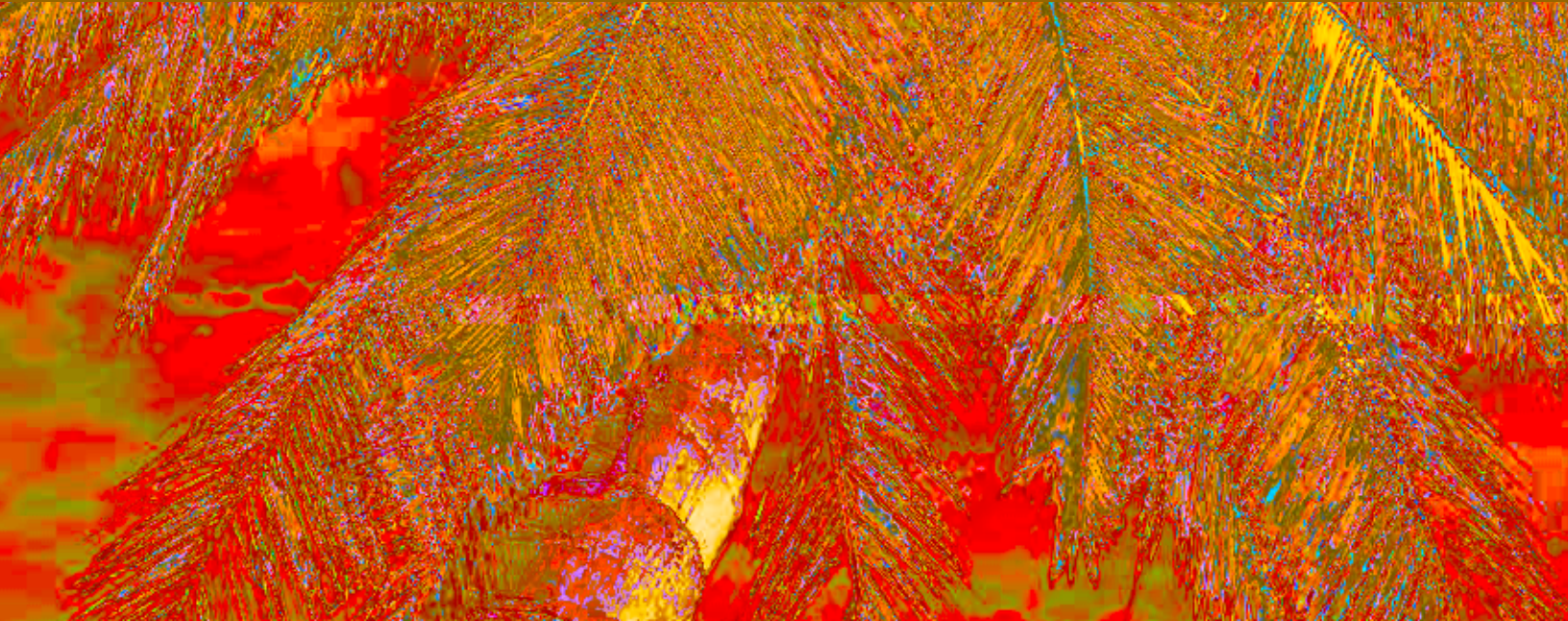

## Panorama Support Tree

Panorama believes that quality service is essential and that every customer worldwide should have more than just one point of contact with us. As a global company, Panorama has a number of international sales representatives responsible for countries and regions. This enables Panorama to have someone on the ground who knows the local market and can use this knowledge to help customers.

Whilst the local sales representative is ultimately responsible for all customers in their region, they may not be available 24/7. Therefore, Panorama's headquarters in London is able to liaise with the customer over issues like purchase orders, delivery schedules, shipping details and information, sending of samples for evaluation, technical datasheets and other matters that our international sales representative may not be able to deal with immediately.

Panorama aims to answer all questions, and deal with any problems or queries within 24 hours of the original email being sent.

### Important Waiver Information

All information and data in this catalog is intended to provide an indication of the performance of our products under particular circumstances and none of it implies a guarantee of performance or fitness for any particular purpose.

We strongly encourage our customers to conduct their own tests in order to establish the appropriate product for any particular application.

All products should only be installed by a properly qualified installer familiar with appropriate local laws and regulations. We advise our customers to consult and comply with the appropriate Panorama Antennas installation instructions.

All specifications and product information in this catalog is subject to change without notice.

### California Proposition 65

California's Proposition 65 entitles California customers to special warnings for products that contain chemicals known to the state of California to cause cancer and birth defects or other reproductive harm if those products could expose customers to such chemicals above certain threshold levels. We care about our customers' safety and hope that the information below helps with buying decisions.

We are providing the following warning for products in this catalog:  
**WARNING:** This product contains chemicals known to the State of California to cause cancer and birth defects or other reproductive harm.

# Global Offices

## UK Head Quarters

Panorama Antennas Ltd  
Frogmore  
London, SW18 1HF  
United Kingdom

T: +44 (0)20 8877 4444  
F: +44 (0)20 8877 4477  
E: enquiry@panorama-antennas.com  
W: www.panorama-antennas.com

## Australia & New Zealand

T: +61 1300 859 833  
E: au.sales@panorama-antennas.com

## Austria, Germany & Switzerland

T: +49 2303 902 88 44  
E: de.sales@panorama-antennas.com

## France

T: +33 672 540 474  
E: fr.sales@panorama-antennas.com

## Latin America

T: +55 11 94131686  
E: br.sales@panorama-antennas.com

## Poland

T: +48 22 758 14 14  
E: pl.sales@panorama-antennas.com

## Portugal & Spain

T: +34 662 670 320  
E: es.sales@panorama-antennas.com

## Russia

T: +7 916 137 0646  
E: ru.sales@panorama-antennas.com

## Scandinavia

T: +358 405 679 002  
E: fi.sales@panorama-antennas.com

## USA & Canada

T: +1 817 539 1888  
E: us.sales@panorama-antennas.com



**Panorama Antennas Inc.**  
1551 Heritage Parkway - Suite 101  
Mansfield, TX 76063-8333  
USA

T: +1 817-539-1888  
F: +1 817-539-1881

[us.sales@panorama-antennas.com](mailto:us.sales@panorama-antennas.com)  
[www.panorama-antennas.com](http://www.panorama-antennas.com)